

# KOMATSU®

## **D65EX-18** **D65PX-18** **D65WX-18**

*Tier 4 Final Engine*

### CRAWLER DOZER



Photos may include optional equipment.

#### **NET HORSEPOWER**

217 HP @ 1950 rpm  
162 kW @ 1950 rpm

#### **OPERATING WEIGHT**

##### **SIGMADOZER®**

D65EX-18: 45,628 lb 20740 kg  
D65WX-18: 48,760 lb 22117 kg

##### **Straight Tilt Dozer**

D65PX-18: 48,444 lb 22020 kg

##### **Power Angle Tilt Dozer**

D65EX-18: 48,796 lb 22180 kg  
D65PX-18: 51,960 lb 23659 kg  
D65WX-18: 51,529 lb 23373 kg

#### **BLADE CAPACITY**

##### **SIGMADOZER®**

D65EX-18: 7.3 yd<sup>3</sup> 5.6 m<sup>3</sup>  
D65WX-18: 7.7 yd<sup>3</sup> 5.9 m<sup>3</sup>

##### **Straight Tilt Dozer**

D65PX-18: 4.8 yd<sup>3</sup> 3.7 m<sup>3</sup>

##### **Power Angle Tilt Dozer**

D65EX-18: 5.6 yd<sup>3</sup> 4.3 m<sup>3</sup>  
D65PX-18: 5.8 yd<sup>3</sup> 4.4 m<sup>3</sup>  
D65WX-18: 5.8 yd<sup>3</sup> 4.4 m<sup>3</sup>

# D65

# WALK-AROUND

D65EX/PX/WX-18



## NET HORSEPOWER

217 HP @ 1950 rpm  
162 kW @ 1950 rpm

## OPERATING WEIGHT

**SIGMADOZER®**  
D65EX-18: 45,628 lb 20740 kg  
D65WX-18: 48,760 lb 22117 kg  
**Straight Tilt Dozer**  
D65PX-18: 48,444 lb 22020 kg  
**Power Angle Tilt Dozer**  
D65EX-18: 48,796 lb 22180 kg  
D65PX-18: 51,960 lb 23659 kg  
D65WX-18: 51,529 lb 23373 kg

## BLADE CAPACITY

**SIGMADOZER®**  
D65EX-18: 7.3 yd<sup>3</sup> 5.6 m<sup>3</sup>  
D65WX-18: 7.7 yd<sup>3</sup> 5.9 m<sup>3</sup>  
**Straight Tilt Dozer**  
D65PX-18: 4.8 yd<sup>3</sup> 3.7 m<sup>3</sup>  
**Power Angle Tilt Dozer**  
D65EX-18: 5.6 yd<sup>3</sup> 4.3 m<sup>3</sup>  
D65PX-18: 5.8 yd<sup>3</sup> 4.4 m<sup>3</sup>  
D65WX-18: 5.8 yd<sup>3</sup> 4.4 m<sup>3</sup>

Photos may include optional equipment.



## OUTSTANDING PRODUCTIVITY & FUEL ECONOMY

Versatile Power Angle Tilt (PAT) blade can be used in many applications.

Innovative SIGMADOZER® blade reduces digging resistance and smoothly rolls material up for increased blade loads.

Auto shift transmission with lock-up torque converter improves fuel consumption and performance.



**SAA6D114E-6 diesel engine** provides excellent fuel economy. This engine is EPA Tier 4 Final emissions certified.

**Komatsu Variable Geometry Turbocharger (KVGIT)** uses a hydraulic actuator to provide optimum air flow under all speed and load conditions.

**Includes a wide core A/C condenser** and bowl-type precleaner on the cab air intake for improved performance in high debris applications.

**Komatsu Diesel Particulate Filter (KDPF)** captures 90% of particulate matter and provides automatic regeneration that does not interfere with daily operation.

**Selective Catalytic Reduction (SCR)** removes NOx exhaust gases automatically by injecting DEF (diesel exhaust fluid) and is seamless to the operator.

**Auto Idle Shutdown** helps reduce non-productive engine idle time and operating costs.

**KOMTRAX®** sends information to a secure website including machine location, SMR, error codes, cautions, maintenance items, fuel usage, fuel levels, DEF levels, ambient conditions and much more.

### Integrated ROPS cab features include:

- Large, quiet, and pressurized cab
- Improved visibility with integrated ROPS structure
- New heated air-suspension seat with high capacity
- Aux plug for audio player and two 12 volt connections

### Large color monitor:

- Easy-to-read and use large 7" high-resolution multi-color monitor
- Ecology guidance
- On-board diagnostics

**Rearview Monitoring System (standard)** displays the area behind the machine onto the wide landscape view color monitor screen.

**Parallel Link Undercarriage System (PLUS)** with lubricated rotating bushings provides up to double the wear life and lower repair and maintenance costs.

**Triple Labyrinth Final Drive** improves durability.

### Ergonomic Operator Controls

- Palm Command Control System (PCCS) comfortably fits the operator's hands
- Automatic/manual selectable transmission shift mode
- Forward/reverse shift pattern preset function

### Komatsu designed and manufactured components

### Enhanced provision for Topcon® Machine control (standard).

Easy bolt-on finishing kit makes the machine plug-and play.

**Hydrostatic Steering System (HSS)** provides smooth power to both tracks when turning. Counter-rotation is available when in neutral.

### Power and Economy Modes

"Power" can be selected for maximum productivity, "Economy" for an additional 10% fuel savings under moderate loads.

### Battery Disconnect Switch

Eliminates power draw when storing the machine.

**Operator Identification System** can track machine operation for up to 6 operators.



# PERFORMANCE FEATURES

## KOMATSU NEW ENGINE TECHNOLOGIES

### New Tier 4 Final Engine

The Komatsu SAA6D114E-6 engine is EPA Tier 4 Final emissions certified and provides exceptional performance while reducing fuel consumption. Based on Komatsu proprietary technologies developed over many years, this new diesel engine reduces nitrogen oxides (NOx) by more than 80% when compared to Tier 4 interim levels. Through the in-house development and production of engines, electronics, and hydraulic components, Komatsu has achieved great advancements in technology, providing high levels of performance and efficiency in virtually all applications.

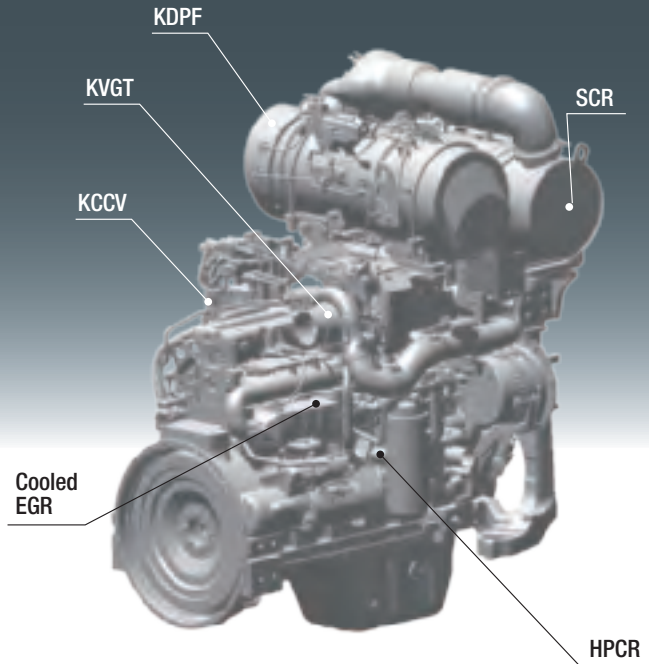

### Technologies Applied to New Engine

#### Heavy-duty aftertreatment system

This new system combines a Komatsu Diesel Particulate Filter (KDPF) and Selective Catalytic Reduction (SCR). The SCR NOx reduction system injects the correct amount of DEF at the proper rate, thereby decomposing NOx into non-toxic water (H<sub>2</sub>O) and nitrogen gas (N<sub>2</sub>).

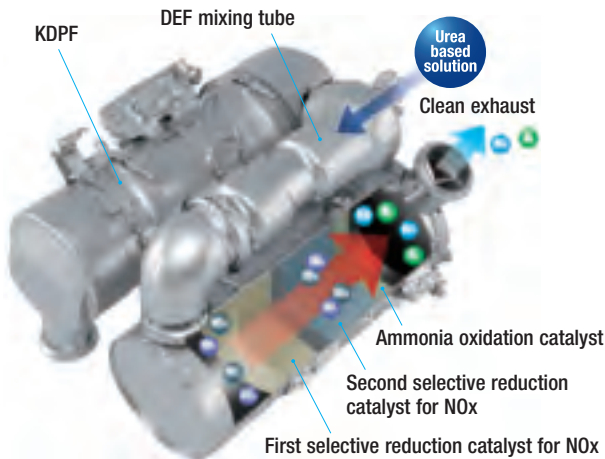

#### Advanced Electronic Control System

The electronic control system performs high-speed processing of all signals from sensors installed in the vehicle providing total control of equipment in all conditions of use. Engine condition information is displayed via an on-board network to the monitor inside the cab, providing necessary information to the operator. Additionally, managing the information via KOMTRAX helps customers keep up with required maintenance.

#### Komatsu Variable Geometry Turbocharger (KVGT) system

The KVGT system features proven Komatsu design hydraulic technology for variable control of air-flow and supplies optimal air according to load conditions. The upgraded version provides better exhaust temperature management.

#### Heavy-duty cooled Exhaust Gas Recirculation (EGR) system

The system recirculates a portion of exhaust gas into the air intake and lowers combustion temperatures, thereby reducing NOx emissions. EGR gas flow has been decreased for Tier 4 Final with the addition of SCR technology. The system achieves a dynamic reduction of NOx, while helping reduce fuel consumption below Tier 4 Interim levels.

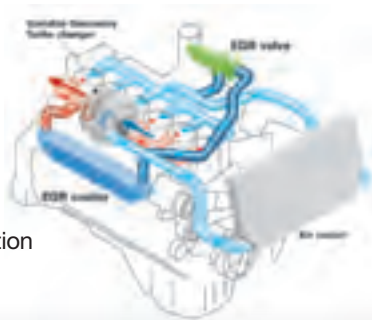

### Komatsu Auto Idle Shutdown

Komatsu auto idle shutdown automatically shuts the engine down after idling for a set period of time to reduce unnecessary fuel consumption and exhaust emissions. The amount of time before the engine is shutdown can be easily programmed from 5 to 60 minutes.



### Secondary Engine Shutdown Switch

A secondary switch is at the side of the front console to shut down the engine.



### Heavy-Duty High-Pressure Common Rail (HPCR) Fuel Injection System

The system is designed to achieve an optimal injection of high-pressure fuel by means of computerized control, providing close to complete combustion to reduce PM emissions. While this technology is already used in current engines, the new system uses high pressure injection, thereby reducing both PM emissions and fuel consumption over the entire range of engine operating conditions. The Tier 4 Final engine has advanced fuel injection timing for reduced fuel consumption and lower soot levels.

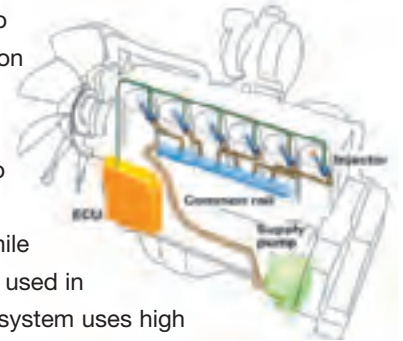

### Hydraulically Driven Cooling Fan

The engine cooling fan rotation speed is electronically controlled. The fan rotation speed depends on engine coolant, powertrain oil and hydraulic oil temperatures. The higher the temperature the higher the fan speed. This system increases fuel efficiency, reduces the operating noise levels and requires less horsepower than a belt driven fan. The fan is manually reversible by the operator for periodic cleaning.





# PRODUCTIVITY & FUEL ECONOMY FEATURES

- 1 Automatic transmission with lockup torque converter
- 2 KOMATSU SAA6D114E-6 engine
- 3 SIGMADOZER®

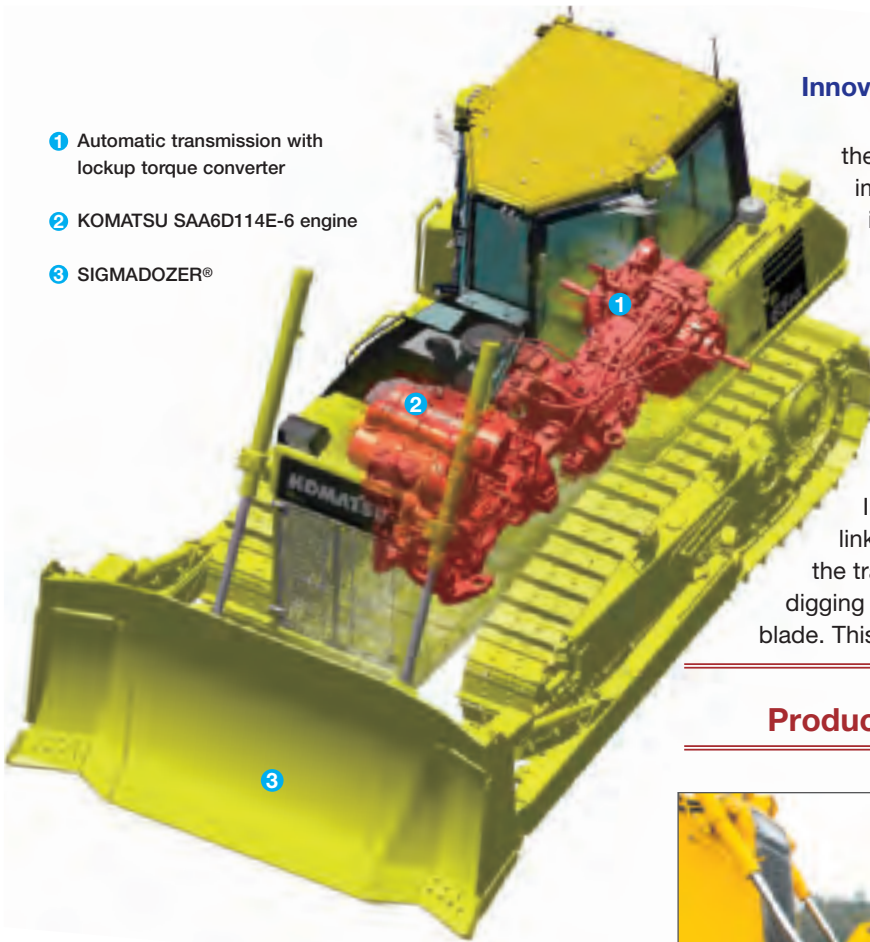

## Innovative SIGMADOZER®

Based on a completely new digging theory, SIGMADOZER® dramatically improves dozing performance and increases productivity. A new frontal design concept adopted for digging and rolling up at the center of the blade increases soil holding capacity and simultaneously reduces sideways spillage. Reduced digging resistance produces smoother flow of material, enabling the dozing of larger quantities of material with less power. In addition, adoption of a new blade linkage system holds the blade closer to the tractor for improved visibility, enhanced digging force and reduced lateral sway of the blade. This is the next generation of dozer blades.

**Production increased by 15%**

Compared to conventional Semi-U blade



SIGMADOZER®



Semi-U blade

## New Fuel Efficient Bulldozer

The new D65EX/PX/WX-18 has achieved both high levels of productivity and fuel economy with the SIGMADOZER® blade, automatic transmission with lockup torque converter and new Tier 4 Final engine. The SIGMADOZER® blade, based on completely new digging theory, dramatically increases production. This bulldozer significantly improves fuel efficiency compared with our conventional model.

SIGMADOZER®



Automatic transmission with lockup torque converter



Tier 4 Final engine



**FUEL EFFICIENCY:**  
**30% increase**

Compared to machine with Semi-U blade and manual shift transmission

Production Increased By

**15%**

(compared with a conventional Semi-U blade model)

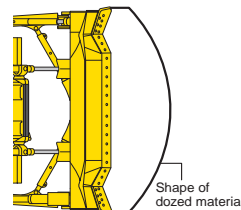

SIGMADOZER®

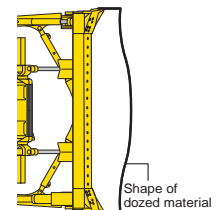

Semi-U blade

### Automatic Transmission with Lockup Torque Converter

A sharp reduction in fuel consumption and greater power train efficiency is achieved by the automatic gearshift transmission and lock up torque converter. The automatic gearshift transmission selects the optimal gear range depending on the working conditions and load. This means the machine is designed to operate at maximum efficiency. (Manual gearshift mode is selectable with a switch)

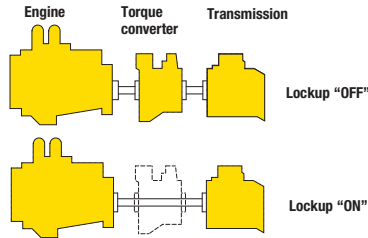

## Fuel consumption reduced by 10%

Compared to machine with manual shift transmission

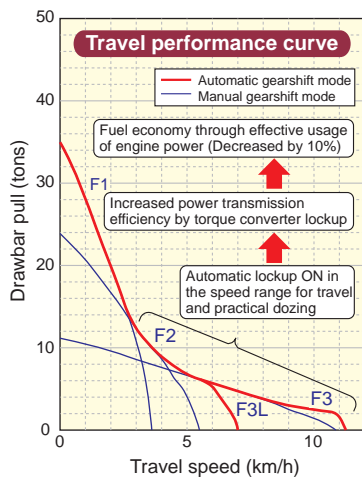

Lockup mechanism of torque converter is automatically actuated to transfer engine power directly to the transmission in usual dozing speed range. Locking up the torque converter eliminates loss of horsepower by 10%. Because the electronically controlled engine is extremely efficient, a decrease in fuel consumption is realized while also maintaining machine power.

### Power Angle Power Tilt Dozer (optional)

A power angle tilt dozer blade with highly durable box-structure frame is available as an option. This blade is available for the EX, WX and PX machines. The hydraulic tilt and angle function expands versatility and productivity in a variety of applications.

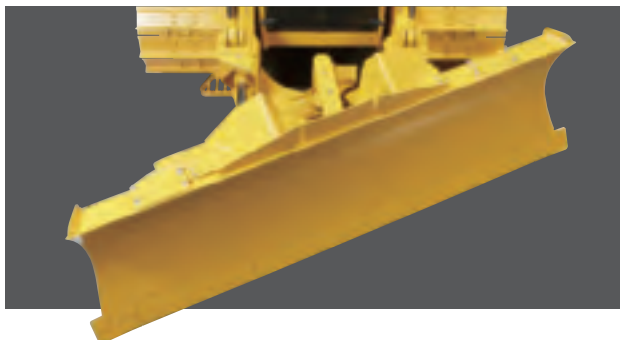

### Automatic/Manual Gearshift Selectable Mode

Automatic or manual gearshift modes can be selected to suit the work at hand. Changing modes is achieved by simply pressing a button on the monitor.

#### Automatic gearshift mode

The mode for general dozing. When a high load is encountered, the transmission automatically shifts down, and when the load is released, it automatically shifts up to quickly and efficiently carry the material. This mode optimizes fuel use and production. The torque converter lockup mechanism is actuated according to load, creating a direct connection between the engine and tracks.

#### Manual gearshift mode

The mode for dozing and ripping rough ground. When enabled, the transmission automatically shifts down when a high load is encountered, but does not shift up when the load is off. The operator can specify whether the auto shift down function is enabled or disabled in manual gearshift mode by selection in the monitor.

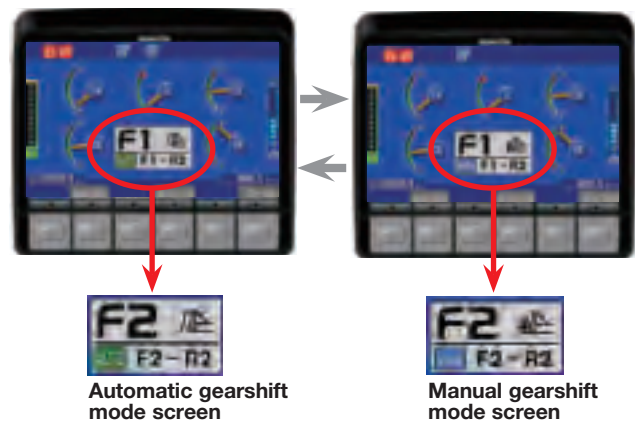

### Selectable Working Mode

Working mode P is the mode aiming for powerful operation and maximum production and mode E for general dozing applications with adequate speed and power while saving energy. For CO<sub>2</sub> reduction and energy saving, the monitor panel allows for switching the working mode with ease, depending on the work at hand.

#### P mode (Power mode)

With P mode, the engine outputs its full power, allowing the machine to perform the work requiring large production, heavy-load work, and uphill work.

#### E mode (Economy mode)

With E mode, the engine outputs enough power for the work without delivering unnecessary power. This mode allows for energy saving operation and is suitable for the work on a ground where the machine may cause shoe slip and the work not requiring large power such as downhill dozing, leveling and light-load work.

# CONTROL FEATURES

## Palm Command Electronic Controlled Travel Control Joystick

Palm command travel joystick provides the operator with a relaxed posture and superb fine control without operator fatigue. Transmission gear shifting is simplified with thumb push buttons.

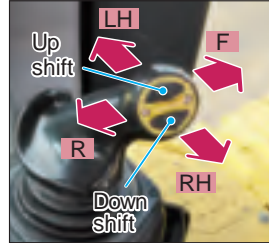

## Gearshift Pattern Preset Function

When the gearshift pattern is set to either <F1-R2>, <F2-R1>, <F2-R2>, <F2-R3L> or <F3L-R3L> in the automatic gearshift mode, the gear automatically shifts to the preset gear when the travel control joystick is set to Forward or Reverse position, reducing round trip repetition work time and operator's efforts. Gearshift pattern <F2-R3L> and <F3L-R3L> are added for high speed leveling operation.

## Electronic Controlled Modulation Valve (ECMV) Controlled Transmission and Brakes

Controller automatically adjusts each clutch engagement depending on travel conditions, providing smooth shockless clutch engagement, improved component life and operator ride comfort.

## Hydrostatic Steering System (HSS) – Smooth, Powerful Turning

The engine power is transmitted to both tracks without power interruption on the inside track for smooth, powerful turns. Counter-rotation while in neutral is available for minimum turning radius providing excellent maneuverability.

## Selectable Auto Downshift in Manual Mode

Auto downshift can now be turned off in manual mode in the mode select section of the monitor. The operator can have full control over the downshift in manual mode.



### Automatic gearshift mode

**F1-R1 MODE**  
Press DOWN switch ↑ ↓ Press UP switch

**F1-R2 MODE**  
Press DOWN switch ↑ ↓ Press UP switch

**F2-R1 MODE**  
Press DOWN switch ↑ ↓ Press UP switch

**F2-R2 MODE**  
Press DOWN switch ↑ ↓ Press UP switch

**F2-R3L MODE**  
Press DOWN switch ↑ ↓ Press UP switch

**F3L-R3L MODE**

### Manual gearshift mode

**F1-R1 MODE**  
Press DOWN switch ↑ ↓ Press UP switch

**F1-R2 MODE**  
Press DOWN switch ↑ ↓ Press UP switch

**F2-R1 MODE**  
Press DOWN switch ↑ ↓ Press UP switch

**F2-R2 MODE**  
Press DOWN switch ↑ ↓ Press UP switch

**F2-R3 MODE**



D65EX/PX/WX-18



# WORKING ENVIRONMENT



## Integrated ROPS Cab

The D65EX/PX/WX-18 has a strong integrated ROPS cab. High rigidity and superb sealing performance sharply reduce noise and vibration for the operator and helps prevent dust from entering the cab. This provides the operator a comfortable working environment. In addition, side visibility is increased because additional external ROPS structure and posts are not required. Outstanding visibility has been achieved.



## Comfortable Ride with New Operator Seat and Cab Damper Mounting

New operator seat is equipped with lumbar support, tilting adjust function and electric heater. It is easy to adjust to the operator's shape and various working conditions and provides for comfortable operation. Also standard seat heat makes it possible to work comfortably in the winter.

The D65EX/PX/WX-18's cab mount uses a cab damper which provides excellent shock and vibration absorption capacity with its long stroke. Cab damper mounts soften shocks and vibration while traveling over adverse conditions, which conventional mounting systems are unable to match. The cab damper spring isolates the cab from the machine body, suppressing vibration and providing a quiet, comfortable operating environment.

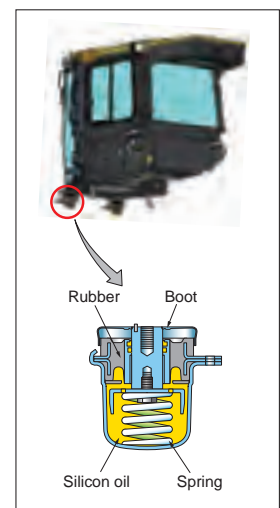

## Rear View Monitoring System

The operator can view the rear of the machine with a color monitor screen.

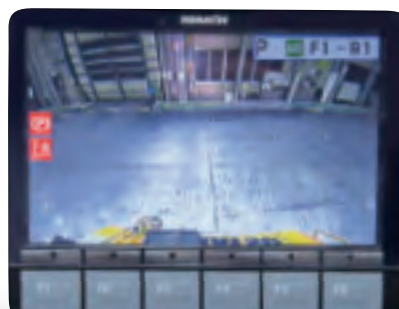

# RELIABILITY & MAINTENANCE FEATURES

## Parallel Link Undercarriage System (PLUS)

Komatsu's innovative Parallel Link Undercarriage System features a rotary bushing that demonstrates high durability in any working conditions. Allowing the bushing to rotate virtually eliminates bushing wear, resulting in doubled service life of the undercarriage when compared with the conventional undercarriage. In addition, wear limits of the link and carrier roller are increased to balance with the extended service life of the bushing.

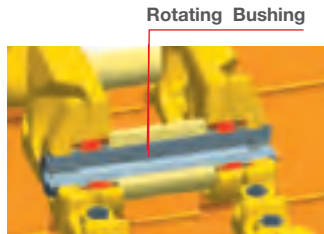

## Self-adjusting Idler Support

Self-adjusting idler support applies a constant spring force to the wear plate of the idler guide to eliminate the play of the idler. This results in reduced noise and vibration as well as extended service life of the wear plate.

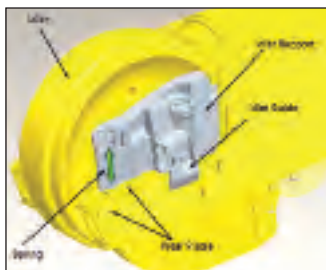

## Oil Pressure Checking Ports

Pressure checking ports for power train components are centralized to promote quick and simple diagnosis.

## Wide Core Cooling System

In addition to improved engine compartment sealing, a wide core cooling system is standard. Radiator, oil cooler and charge air cooler use large square-wave fins spaced at 6 fins per inch. This allows more material to pass through, which helps self-cleaning and reduces maintenance.

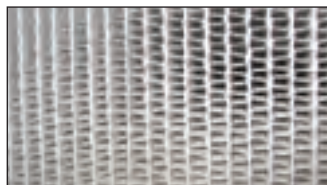

## Multi-monitor with Troubleshooting Function to Help Prevent Critical Machine Trouble

Various meters, gauges and warning functions are centrally arranged on the multi-monitor. The monitor simplifies start-up inspection and promptly warns the operator with a lamp and buzzer if any abnormalities should occur. In addition, countermeasures are indicated in 4 levels to help prevent major problems. Replacement times for oil and filters are also indicated.



## Maintenance Function

When the machine reaches the replacement interval for oil and filters, the monitor panel will display lights to inform the operator.

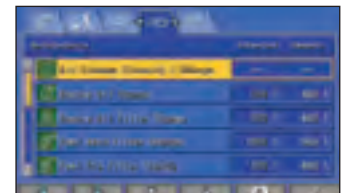

## Battery Disconnect Switch

A standard battery disconnect switch allows a technician to disconnect the power supply before servicing the machine.

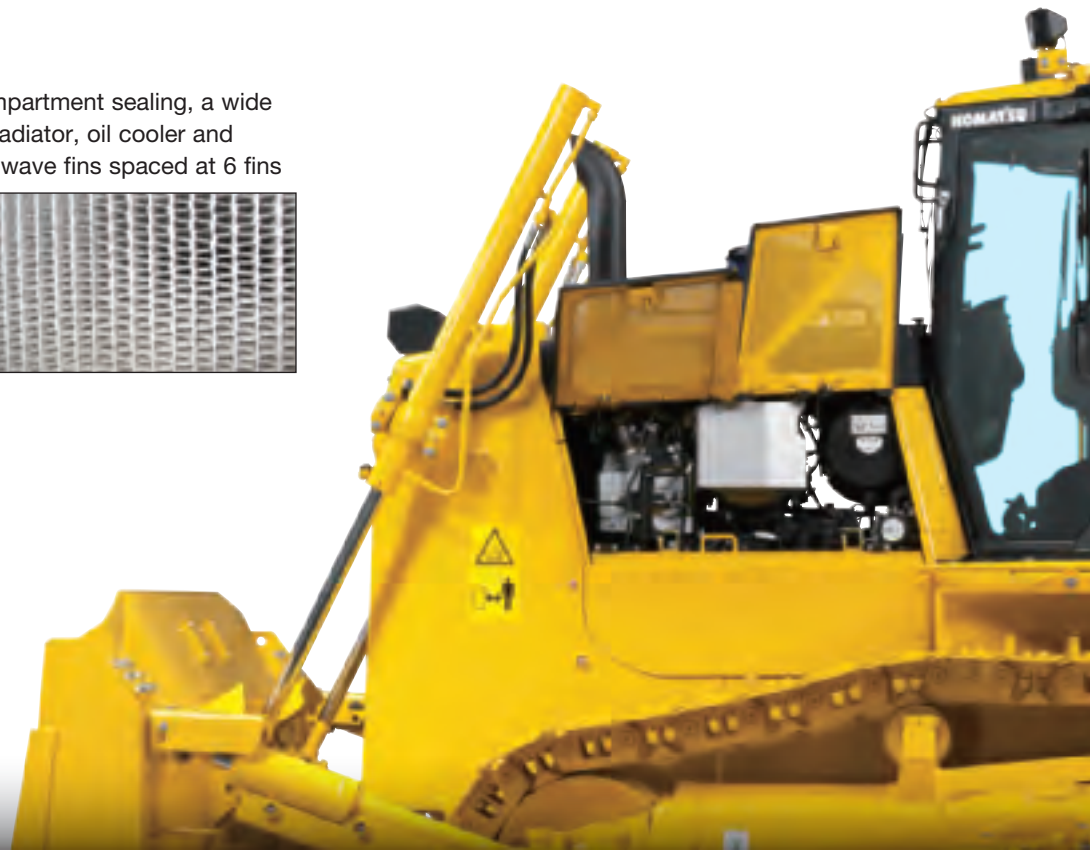

# KOMTRAX EQUIPMENT MONITORING

GET THE WHOLE STORY WITH  
**KOMTRAX**<sup>®</sup>

## ✓ WHAT

- KOMTRAX is Komatsu's remote equipment monitoring and management system
- KOMTRAX **continuously monitors and records** machine health and operational data
- Information such as fuel consumption, utilization, and a detailed history **lowering owning and operating cost**

## ✓ WHO

- KOMTRAX is **standard** equipment on all Komatsu construction products

## ✓ WHEN

- Know when your machines are **running or idling** and make decisions that will improve your fleet utilization
- Detailed movement records ensure you know when and where your equipment is moved
- Up to date records allow you to **know when maintenance is due** and help you plan for future maintenance needs

## ✓ WHERE

- KOMTRAX data **can be accessed virtually anywhere** through your computer, the web or your smart phone
- Automatic alerts keep fleet managers up to date on the latest machine notifications

## ✓ WHY

- Knowledge is power - **make informed decisions** to manage your fleet better
- Knowing your idle time and fuel consumption will help maximize your machine efficiency
- **Take control of your equipment** - any time, anywhere



**KOMTRAX**<sup>®</sup>

For construction and compact equipment.

**KOMTRAX Plus**<sup>™</sup>

For production and mining class machines.



# KOMATSU PARTS & SERVICE SUPPORT



## Every new Komatsu Tier 4 Final construction machine is covered.

The Komatsu CARE program covers all new Komatsu Tier 4 Final construction equipment, whether rented, leased or purchased. For the first 3 years or 2,000 hours, whichever occurs first, you'll receive:

- Regular service at 500, 1,000, 1,500 and 2,000-hr. intervals
- DEF tank breather element replacement at 1,000 hours
- DEF and CCV filters replacement at 2,000 hours
- 50-point inspection by factory-trained technician at each scheduled interval
- Technician labor
- Fluids, oils, coolant, filters, SCR screen, tank breather and parts
- Technician travel to and from your equipment location

Plus two complimentary scheduled KDPF exchanges and SCR system service for 5 years-no hours limits.\*

Service will be performed by a Komatsu Distributor and only Komatsu genuine fluids and filters will be used.

Komatsu CARE® services are available from every Komatsu Distributor in the U.S. and Canada.



## Komatsu CARE® – Extended Coverage

- Extended Coverage can provide peace of mind by protecting customers from unplanned expenses that effect cash flow
- Purchasing extended coverage locks-in the cost of covered parts and labor for the coverage period and helps turn these into fixed costs



## Komatsu Parts Support

- 24/7/365 to fulfill your parts needs
- 9 parts Distribution Centers strategically located across the U.S. and Canada
- Distributor network of more than 300 locations across U.S. and Canada to serve you
- Online part ordering through Komatsu eParts
- Remanufactured components with same-as-new warranties at a significant cost reduction



## Komatsu Oil and Wear Analysis (KOWA)

- KOWA detects fuel dilution, coolant leaks, and measures wear metals
- Proactively maintain your equipment
- Maximize availability and performance
- Can identify potential problems before they lead to major repairs
- Reduce life cycle cost by extending component life

\* Some exclusions apply. Please contact your Komatsu distributor for specific program details.

# SPECIFICATIONS



## ENGINE

Model.....Komatsu SAA6D114E-6\*  
 Type ..... 4-cycle, water-cooled, direct injection  
 Aspiration..... Komatsu variable geometry turbocharged, air-to-air aftercooled  
 Number of cylinders..... 6  
 Bore x stroke..... 114 mm x 144.5 mm **4.49" x 5.69"**  
 Piston displacement..... 8.85 ltr **540 in<sup>3</sup>**  
 Governor.....All-speed and mid-range, electronic  
 Horsepower  
 SAE J1995..... Gross 164 kW **220 HP**  
 ISO 9249 / SAE J1349.....Net 162 kW **217 HP**  
 Rated rpm..... 1950 rpm  
 Fan drive type .....Hydraulic  
 Lubrication system  
 Method..... Gear pump, force lubrication  
 Filter..... Full-flow  
 \*\*EPA Tier 4 Final emissions certified



## TORQFLOW TRANSMISSION

Komatsu TORQFLOW transmission consists of a water-cooled, 3-element, 1-stage, 2-phase, torque converter with lockup clutch, and a planetary gear, multiple-disc clutch transmission which is electronically controlled, hydraulically actuated and force-lubricated for optimum heat dissipation. Shift lock lever and neutral safety switch.

Travel speed	Forward	Reverse
<b>1st</b>	3.7 km/h <b>2.3 mph</b>	4.5 km/h <b>2.8 mph</b>
<b>2nd</b>	5.6 km/h <b>3.5 mph</b>	6.7 km/h <b>4.2 mph</b>
<b>3rd L</b>	7.3 km/h <b>4.5 mph</b>	8.7 km/h <b>5.4 mph</b>
<b>3rd</b>	11.3 km/h <b>7.0 mph</b>	13.6 km/h <b>8.5 mph</b>

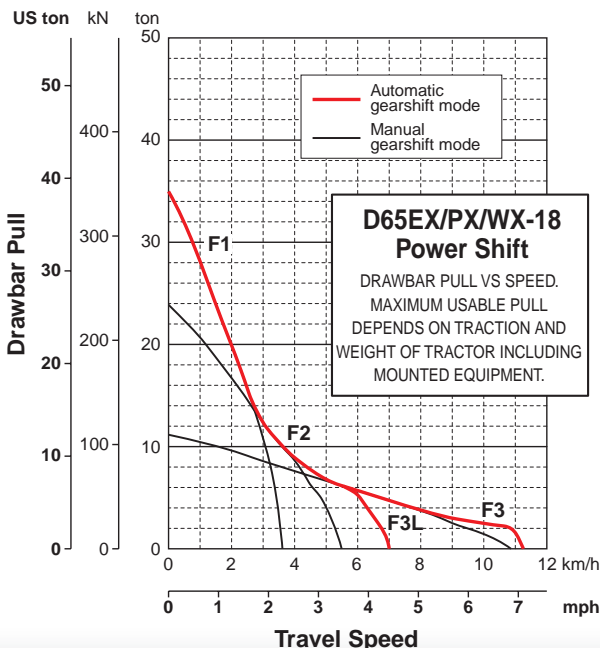

## STEERING SYSTEM

Palm Command Control System (PCCS) lever controls for all directional movements. Pushing the PCCS lever forward results in forward machine travel, while pulling it rearward reverses the machine. Simply tilt the PCCS lever to left to make a left turn. Tilt it to the right for a right turn.

Hydrostatic Steering System (HSS) is powered by steering planetary units and a hydraulic pump and motor. Counter-rotation turns are also available. Wet, multiple-disc, pedal-controlled service brakes are spring-actuated and hydraulically released. Gear shift lock lever also applies parking brake.

Minimum turning radius

D65EX-18.....	1.9 m <b>6'3"</b>
D65EX-18 with PAT.....	2.0 m <b>6'7"</b>
D65PX-18.....	2.2 m <b>7'3"</b>
D65WX-18.....	2.1 m <b>6'11"</b>



## UNDERCARRIAGE

Suspension..... Oscillating equalizer bar and pivot shaft  
 Track roller frame ..... Monocoque, large section, durable construction

Rollers and idlers ..... Lubricated

Track shoes

Parallel Link Undercarriage System (PLUS) with lubricated rotating bushings for extended system wear life and lower maintenance costs. Track tension is easily adjusted with grease gun.

### Tractor for outside mounted blade (Straight Tilt, SIGMADOZER®)\*

	D65EX-18	D65PX-18	D65WX-18
Number of track rollers (each side)	7	8	7
Type of shoes (standard)	Single grouser	Single grouser	Single grouser
Number of shoes (each side)	42	45	42
Grouser height	mm in 65 <b>2.6"</b>	65 <b>2.6"</b>	65 <b>2.6"</b>
Shoe width (standard)	mm in 610 <b>24"</b>	915 <b>36"</b>	760 <b>30"</b>
Ground contact area	cm <sup>2</sup> 36234	59935	45145
	in <sup>2</sup> <b>5,616</b>	<b>9,290</b>	<b>6,997</b>
Ground pressure (tractor)	kPa 49.5	32.7	41.1
	kgf/cm <sup>2</sup> 0.51	0.33	0.42
	psi <b>7.22</b>	<b>4.69</b>	<b>5.97</b>
Track gauge	mm ft.in 1880 <b>6'2"</b>	2050 <b>6'9"</b>	2050 <b>6'9"</b>
Length of track on ground	mm ft.in 2970 <b>9'9"</b>	3275 <b>10'9"</b>	2970 <b>9'9"</b>

### Tractor for inside mounted blade (PAT)\*

	D65EX-18	D65PX-18	D65WX-18
Number of track rollers (each side)	7	8	7
Type of shoes (standard)	Single grouser	Single grouser	Single grouser
Number of shoes (each side)	42	45	42
Grouser height	mm in 65 <b>2.6"</b>	65 <b>2.6"</b>	65 <b>2.6"</b>
Shoe width (standard)	mm in 560 <b>22"</b>	760 <b>30"</b>	760 <b>30"</b>
Ground contact area	cm <sup>2</sup> 33265	49780	45145
	in <sup>2</sup> <b>5,156</b>	<b>7,716</b>	<b>6,997</b>
Ground pressure (tractor)	kPa 56.9	39.3	43.9
	kgf/cm <sup>2</sup> 0.58	0.40	0.45
	psi <b>8.25</b>	<b>5.69</b>	<b>6.40</b>
Track gauge	mm ft.in 2050 <b>6'9"</b>	2230 <b>7'4"</b>	2230 <b>7'4"</b>
Length of track on ground	mm ft.in 2970 <b>9'9"</b>	3275 <b>10'9"</b>	2970 <b>9'9"</b>

\*See page 14 for tractor/blade combinations.

# SPECIFICATIONS



## FINAL DRIVES

Double-reduction final drive of spur and planetary gear sets to increase tractive effort and reduce gear tooth stresses for long final drive life. Segmented sprocket teeth are bolt-on for easy replacement.



## HYDRAULIC SYSTEM

Closed-center load sensing system (CLSS) designed for precise and responsive control, and for efficient simultaneous operation.

Hydraulic control units:

All spool valves externally mounted beside the hydraulic tank.  
Piston type hydraulic pump with capacity (discharge flow) of 248 ltr/min **65.5 U.S. gal/min** at rated engine rpm.

Relief valve setting ..... 27.9 MPa 285 kg/cm<sup>2</sup> **4,050 psi**

Control valves:

Spool control valves for SIGMADOZER® or straight tilt dozer

Positions: Blade lift ..... Raise, hold, lower, and float  
Blade tilt ..... Right, hold, and left  
Rear attachment.....Raise, hold, and lower



## SERVICE REFILL CAPACITIES

Fuel tank .....	415 ltr	<b>109.6 U.S. gal</b>
DEF tank .....	23.5 ltr	<b>6.2 U.S. gal</b>
Coolant .....	49 ltr	<b>12.9 U.S. gal</b>
Engine.....	30.5 ltr	<b>8.1 U.S. gal</b>
Torque converter, transmission, bevel gear, and steering system .....	48 ltr	<b>12.7 U.S. gal</b>
Final drive (each side)		
D65EX-18 non PAT .....	16.5 ltr	<b>4.4 U.S. gal</b>
D65EX-18 with PAT .....	22 ltr	<b>5.8 U.S. gal</b>
D65PX-18 .....	22 ltr	<b>5.8 U.S. gal</b>
D65WX-18 .....	22 ltr	<b>5.8 U.S. gal</b>

Spool control valves for Power Angle Tilt dozer

Positions: Blade lift ..... Raise, hold, lower, and float  
Blade tilt ..... Right, hold, and left  
Blade angle ..... Right, hold, and left  
Rear attachment.....Raise, hold, and lower

Hydraulic cylinders..... Double-acting, piston

	Number of cylinders	Bore	
		SIGMADOZER® Straight Tilt Dozer	Power Angle Power Tilt Dozer
Blade lift	2	85 mm <b>3.3"</b>	90 mm <b>3.5"</b>
Blade tilt	1	125 mm <b>4.9"</b>	130 mm <b>5.1"</b>
Blade angle	2	N/A	110 mm <b>4.3"</b>
Ripper lift	1	125 mm <b>4.9"</b>	125 mm <b>4.9"</b>
Pitch angle	1	39° - 53°	52° - 58°

Hydraulic oil capacity (refill): ..... 62 ltr **16.4 U.S. gal**

Ripper equipment (additional volume):

Multi-shank ripper ..... 7 ltr **1.8 U.S. gal**



## DOZER EQUIPMENT

Blade capacities are based on the SAE recommended practice J1265.

Use of high tensile strength steel in moldboard for strengthened blade construction.

	Overall Length With Dozer mm ft.in	Blade Capacity m <sup>3</sup> yd <sup>3</sup>	Blade Width x Height mm ft.in	Max. Lift Above Ground mm ft.in	Max. Drop Below Ground mm ft.in	Max. Tilt Adjustment mm ft.in	Weight Dozer equipment kg lb	Ground Pressure* kPa kg/cm <sup>2</sup> psi
<b>D65EX-18</b> SIGMADOZER®	5490 <b>18'0"</b>	5.61 <b>7.34</b>	3410 x 1425 <b>11'2" x 4'8"</b>	1135 <b>3'9"</b>	500 <b>1'8"</b>	870 <b>2'10"</b>	2390 <b>5,260</b>	55.8/0.57/ <b>8.13</b>
<b>D65EX-18</b> Semi-U Dozer	5307 <b>17'5"</b>	5.61 <b>7.34</b>	3470 x 1425 <b>11'5" x 4'8"</b>	1098 <b>3'7"</b>	440 <b>1'5"</b>	878 <b>2'10"</b>	2375 <b>5,236</b>	55.8/0.57/ <b>8.12</b>
<b>D65EX-18</b> Power Angle Tilt Dozer	5790 <b>19'0"</b>	4.25 <b>5.56</b>	3870 x 1235 <b>12'8" x 4'1"</b>	1170 <b>3'10"</b>	695 <b>2'3"</b>	500 <b>1'8"</b>	2960 <b>6,530</b>	65.4/0.67/ <b>9.53</b>
<b>D65PX-18</b> Straight Tilt Dozer	5680 <b>18'8"</b>	3.69 <b>4.83</b>	3970 x 1100 <b>13'0" x 3'7"</b>	1130 <b>3'8"</b>	535 <b>1'9"</b>	890 <b>2'11"</b>	2100 <b>4,630</b>	36.0/0.37/ <b>5.20</b>
<b>D65PX-18</b> Power Angle Tilt Dozer	5790 <b>19'0"</b>	4.42 <b>5.78</b>	4010 x 1235 <b>13'2" x 4'1"</b>	1170 <b>3'10"</b>	695 <b>2'3"</b>	520 <b>1'8"</b>	2990 <b>6,590</b>	46.4/0.47/ <b>6.73</b>
<b>D65WX-18</b> SIGMADOZER®	5500 <b>18'1"</b>	5.90 <b>7.72</b>	3580 x 1425 <b>11'9" x 4'8"</b>	1135 <b>3'9"</b>	500 <b>1'8"</b>	770 <b>2'6"</b>	2500 <b>5,510</b>	48.0/0.49/ <b>6.97</b>
<b>D65WX-18</b> Power Angle Tilt Dozer	5790 <b>19'0"</b>	4.42 <b>5.78</b>	4010 x 1235 <b>13'2" x 4'1"</b>	1170 <b>3'10"</b>	695 <b>2'3"</b>	520 <b>1'8"</b>	2990 <b>6,590</b>	50.7/0.52/ <b>7.36</b>

\*Ground pressure shows tractor, ROPS cab, full fluids, operator, standard equipment and applicable blade (EX, WX, PAT with counterweight).

D65EX/PX/WX-18





## DIMENSIONS — OUTSIDE MOUNTED DOZER BLADE

	D65EX-18 SIGMADOZER®	D65PX-18 Straight Tilt Dozer	D65WX-18 SIGMADOZER®
A	5490 mm <b>18'0"</b>	5680 mm <b>18'8"</b>	5500 mm <b>18'1"</b>
B	1880 mm <b>6'2"</b>	2050 mm <b>6'9"</b>	2050 mm <b>6'9"</b>
C	3160 mm <b>10'5"</b> **	3160 mm <b>10'5"</b> **	3160 mm <b>10'5"</b> **
D	3085 mm <b>10'1"</b>	3085 mm <b>10'1"</b>	3085 mm <b>10'1"</b>
E	2970 mm <b>9'9"</b>	3275 mm <b>10'9"</b>	2970 mm <b>9'9"</b>
F	610 mm <b>24"</b>	915 mm <b>36"</b>	760 mm <b>30"</b>
G	65 mm <b>2.6"</b>	65 mm <b>2.6"</b>	65 mm <b>2.6"</b>

\*3350 mm **11'0"** is overall height if Komatsu sweeps are installed.

Ground clearance ..... 415 mm **1'4"**

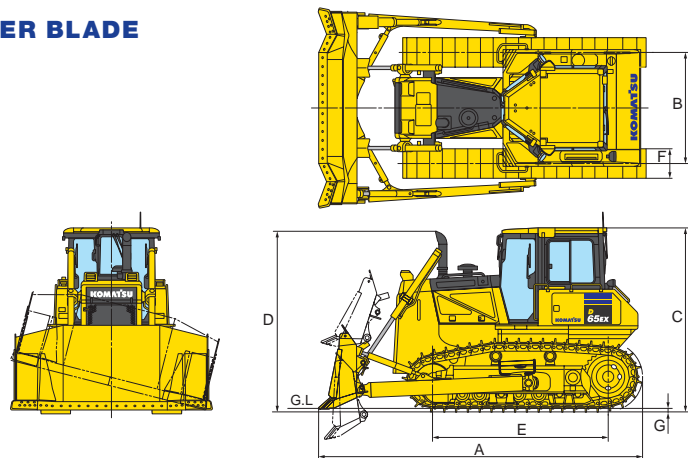

Shown with SIGMADOZER® (D65EX-18) single grouser shoe.



## DIMENSIONS — PAT DOZER BLADE

	D65EX-18 PAT Dozer	D65PX-18 PAT Dozer	D65WX-18 PAT Dozer
A	5790 mm <b>19'0"</b>	5790 mm <b>19'0"</b>	5790 mm <b>19'0"</b>
B	2050 mm <b>6'9"</b>	2230 mm <b>7'4"</b>	2230 mm <b>7'4"</b>
C	3160 mm <b>10'5"</b> **	3160 mm <b>10'5"</b> **	3160 mm <b>10'5"</b> **
D	3085 mm <b>10'1"</b>	3085 mm <b>10'1"</b>	3085 mm <b>10'1"</b>
E	2970 mm <b>9'9"</b>	3275 mm <b>10'9"</b>	2970 mm <b>9'9"</b>
F	560 mm <b>22"</b>	760 mm <b>30"</b>	760 mm <b>30"</b>
G	65 mm <b>2.6"</b>	65 mm <b>2.6"</b>	65 mm <b>2.6"</b>
H	3545 mm <b>11'8"</b>	3670 mm <b>12'0"</b>	3670 mm <b>12'0"</b>

\*3350 mm **11'0"** is overall height if Komatsu sweeps are installed.

Ground clearance ..... 415 mm **1'4"**

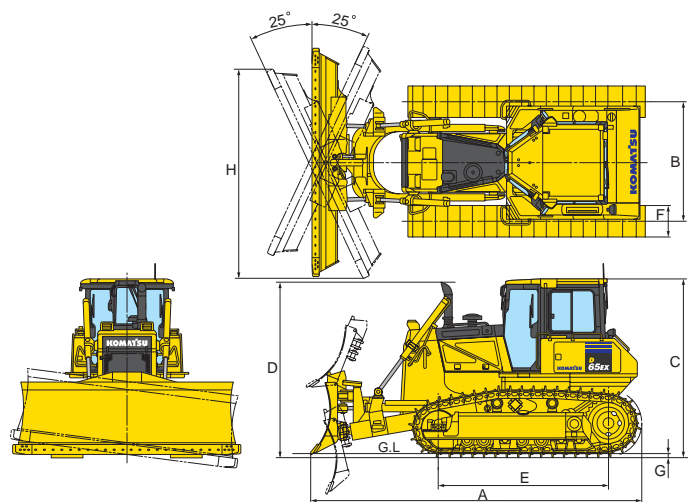

Shown with Power Angle Tilt dozer (D65EX-18) single grouser shoe.



## OPERATING WEIGHT

Tractor weight:

Including ROPS cab, rated capacity of lubricant, hydraulic control unit, coolant, full fuel tank, operator, and standard equipment.

D65EX-18	18420 kg	<b>40,520 lb</b>
D65PX-18	20000 kg	<b>44,000 lb</b>
D65WX-18	18930 kg	<b>41,650 lb</b>

for PAT dozer (EX, WX with rear counterweight)

D65EX-18	19290 kg	<b>42,440 lb</b>
D65PX-18	19970 kg	<b>43,930 lb</b>
D65WX-18	20190 kg	<b>44,420 lb</b>

Operating weight:

Including SIGMADOZER® (EX/WX) or straight tilt dozer (PX) or Power Angle Tilt dozer, ROPS cab, operator, standard equipment, rated capacity of lubricant, hydraulic control unit, coolant, and full fuel tank.

D65EX-18	20740 kg	<b>45,630 lb</b>
D65PX-18	22020 kg	<b>48,440 lb</b>
D65WX-18	22117 kg	<b>48,760 lb</b>

for PAT dozer (EX, WX with rear counterweight)

D65EX-18	22180 kg	<b>48,800 lb</b>
D65PX-18	23659 kg	<b>51,960 lb</b>
D65WX-18	23373 kg	<b>51,529 lb</b>



## STANDARD EQUIPMENT FOR BASE MACHINE\*

- Air cleaner, double element with dust indicator
- Alternator, 90 ampere/24V
- Auto idle shutdown function
- Backup alarm
- Batteries, 200 Ah/2 x 12V
- Battery disconnect switch
- Blade lift cylinders
- Color monitor, LCD
- Decelerator pedal
- Engine hood
- Engine intake centrifugal precleaner
- Engine, gull-wing side covers
- Engine shutdown secondary switch
- Fenders
- Front pull hook
- High mount foot rests
- Horn, warning
- Hydraulic driven radiator cooling fan with reverse clean mode
- Hydraulics for rear equipment
- KOMTRAX® Level 5
- Komatsu Diesel Particulate Filter (KDPF)
- Komatsu Variable Geometry Turbocharger (KVG-T)
- Locks, filler caps and covers
- Muffler with curved exhaust pipe
- Oil pressure check ports for power train
- Operator ID function
- PM service connector
- Radiator mask, heavy-duty, hinged, perforated
- Radiator reserve tank
- Rear cover
- ROPS cab\*\*
  - 75 dB operator ear noise level
  - Air conditioner
  - Cab accessories
    - 12V power supply (2 ports)
      - Cup holder
      - Rearview mirror
      - Rear view monitoring (1 camera)
      - AM/FM Radio w/remote AUX plug (3.5 mm)
    - Shovel holder
    - Work lights
      - 2 front, hood mounted
      - 2 front, cab mounted
      - 1 rear, left fender mounted
      - 2 rear, cab mounted
  - Seat, air suspension, fabric, heated low back, rotates 12.5° to right, headrest
  - Seat belt, 76 mm 3", retractable
  - Seat belt indicator
  - Sealed electrical connectors
  - Secondary engine shutoff switch
  - Starting motor, 11.0 kW/24V

- Steering system:
    - Hydrostatic Steering System (HSS)
  - Torque converter with auto lock-up
  - Track roller guards, center and end sections
  - Track shoe assembly
    - Heavy-Duty lubricated rotary bushing (PLUS) track
      - 560 mm 22" single grouser shoe (EX with PAT)
      - 610 mm 24" single grouser shoe (EX with outside mount blade)
      - 760 mm 30" single grouser shoe (WX with outside mount blade)
      - 760 mm 30" single grouser shoe (PX, WX with PAT)
      - 915 mm 36" single grouser shoe (PX with outside mount blade)
  - Transmission with auto/manual shift modes
  - Underguards, heavy duty
    - Hinged belly pan
    - Transmission
  - Water separator
  - Wide core cooling package
- \* Dozer assembly and rear mounted equipment are not included in base machine standard equipment
- \*\* Cab meets OSHA/MSHA ROPS and FOPS Level 2 standards



## OPTIONAL EQUIPMENT

- Dozer assembly
- Drawbar, long type
- Hitch
- Rear counterweight 850 kg **1,870 lb**
- Straight tilt frame for use with allied blades
- Topcon® Plug-N-Play bolt-on finishing kit
- Track roller guard, full length
- 560 mm 22" single grouser HD (EX)
- 760 mm 30" extreme service shoes
- 915 mm 36" extreme service shoes

### Multi-shank ripper (for D65EX/WX)

Weight.....	1920 kg <b>4,230 lb</b>
Beam length.....	2170 mm <b>7'1"</b>
Maximum lift above ground.....	640 mm <b>2'1"</b>
Maximum digging depth.....	590 mm <b>1'11"</b>



## ALLIED MANUFACTURER'S ATTACHMENTS (SHIPPED LOOSE)

- Guarding - Medford
  - Front sweeps (open top) 299 kg **660 lb**
  - Front sweeps (w/ top cover plate) 481 kg **1060 lb**
  - Hinged cab side screens 79 kg **175 lb**
  - Hinged cab rear screen 91 kg **200 lb**
  - Tank guards 404 kg **890 lb**
- Hydraulic winch - Allied H6H 1325 kg **2,900 lb**
- Mechanical angle blade - Rockland 1100 kg **2,425 lb**



AESS868-02

©2016 Komatsu America Corp.

Printed in USA

AD03(2.5M)OTP

03/16 (EV-1)

# KOMATSU®

*Note: All comparisons and claims of improved performance made herein are made with respect to the prior Komatsu model unless otherwise specifically stated.*

www.komatsuamerica.com

Komatsu America Corp. is an authorized licensee of Komatsu Ltd. Materials and specifications are subject to change without notice

**KOMATSU®**, Komatsu Care® and KOMTRAX® are registered trademarks of Komatsu Ltd.

All other trademarks and service marks used herein are the property of Komatsu Ltd., Komatsu America Corp. or their respective owners or licensees.