



D6/D6 XE

Track-Type Tractors

Technical Specifications

Engine

Engine Model	Cat® C9.3B	
Emissions	U.S. EPA Tier 4 Final, EU Stage V, Korea Tier 4 Final	
Build Number	20A	
Net Power (Rated) – D6 2,200 rpm/D6 XE 1,700 rpm		
ISO 9249/SAE J1349	161 kW	215 hp
ISO 9249/SAE J1349 (DIN)	219 hp	
D6 Engine Power (Maximum) – 1,200 rpm		
ISO 14396	187 kW	251 hp
ISO 14396 (DIN)	254 hp	
D6 XE Engine Power (Maximum) – 1,400 rpm		
ISO 14396	177 kW	237 hp
ISO 14396 (DIN)	241 hp	
Bore	115 mm	4.5 in
Stroke	149 mm	5.9 in
Displacement	9.3 L	567 in ³

- The new Cat C9.3B engine features a new high pressure common rail fuel system, simplified engine system electronics, and simplified air system through the removal of the previously used exhaust gas recirculation (EGR) system.
- The XE drive train allows the engine to operate in a tighter rpm range, 1,400-1,700 rpm, which helps extend engine life and provide improved fuel economy. The increased drive train efficiency also allows the machine to provide more engine power to the ground, resulting in greater machine performance.

- Net power advertised is the power available at the engine flywheel when the engine is equipped with a fan, air cleaner, clean emissions module and alternator.
- No derating required up to 2286 m (7,500 ft). Above this, automatic derating occurs.
- All non-road Tier 4 Interim and Final, Stage IIIB, IV and V and Korea Tier 4 Final diesel engines are required to use only ultra-low sulfur diesel (ULSD) fuels containing 15 ppm (mg/kg) sulfur or less. Biodiesel blends up to B20 (20% blend by volume) are acceptable when blended with 15 ppm (mg/kg) sulfur or less ULSD. B20 should meet ASTM D7467 specification (biodiesel blend stock should meet Cat biodiesel spec, ASTM D6751 or EN 14214). Cat DEO-ULS™ or oils that meet the Cat ECF-3, API CJ-4, and ACEA E9 specification are required. Consult your OMM for further machine specific fuel recommendations.
- Diesel Exhaust Fluid (DEF) used in Cat Selective Catalytic Reduction (SCR) systems must meet the requirements outlined in the International Organization for Standardization (ISO) standard 22241.

D6 XE Drive Train

Type	Electric Drive
Electric Drive System	715 Volts
Nominal Voltage	

D6/D6 XE Track-Type Tractors Specifications

Maximum Drawbar Power

D6	114 kW	153 hp
D6 XE	119 kW	160 hp

D6 Travel Speed

1.0 Forward	3.6 km/h	2.2 mph
1.5 Forward	4.9 km/h	3.0 mph
2.0 Forward	6.5 km/h	4.0 mph
2.5 Forward	9.2 km/h	5.7 mph
3.0 Forward	11.7 km/h	7.2 mph
1.0 Reverse	3.6 km/h	2.2 mph
1.5 Reverse	4.9 km/h	3.0 mph
2.0 Reverse	6.5 km/h	4.0 mph
2.5 Reverse	8.7 km/h	5.4 mph
3.0 Reverse	11.7 km/h	7.2 mph

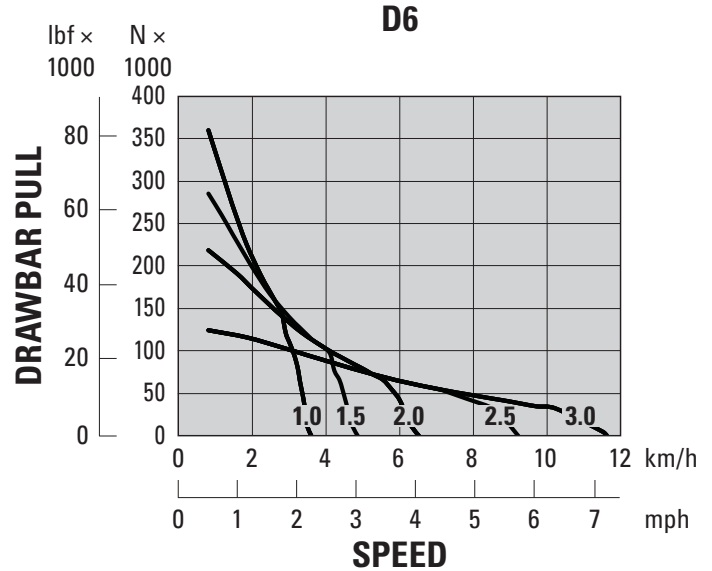

NOTE: Usable pull will depend on traction and weight of machine.

D6 XE Travel Speed

1.0 Forward	3.6 km/h	2.2 mph
1.5 Forward	4.9 km/h	3.0 mph
2.0 Forward	6.5 km/h	4.0 mph
2.5 Forward	9.2 km/h	5.7 mph
3.0 Forward	11.7 km/h	7.2 mph
1.0 Reverse	3.6 km/h	2.2 mph
1.5 Reverse	4.9 km/h	3.0 mph
2.0 Reverse	6.5 km/h	4.0 mph
2.5 Reverse	9.2 km/h	5.7 mph
3.0 Reverse	11.7 km/h	7.2 mph

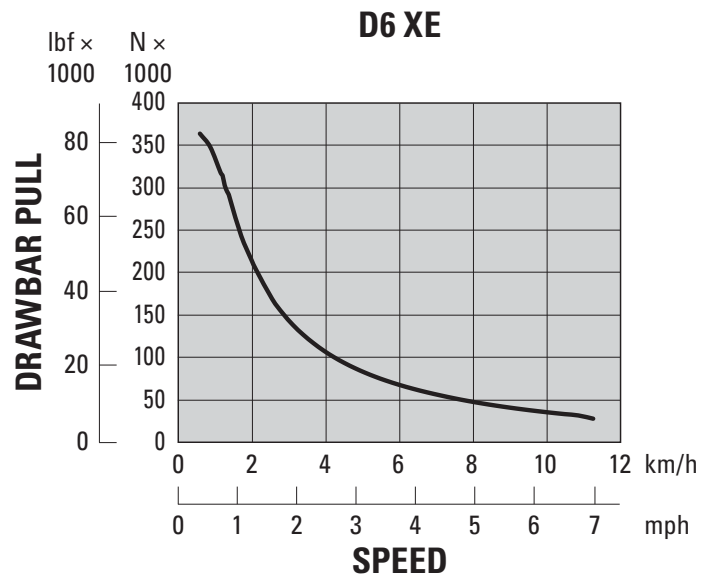

NOTE: Usable pull will depend on traction and weight of machine.

- The fully automatic D6 4-speed transmission, with lock-up clutch torque divider, continuously optimizes gear and engine speed for the application.
- The D6 XE Electric Drive power train has no gears to shift. The dozer automatically optimizes power and efficiency for the application and provides constant power to the ground.
- Thirty ground speed selections are available for both power trains, from 0.0 to 3.0 in 0.1 increments.

D6/D6 XE Track-Type Tractors Specifications

Hydraulic Controls – Maximum Operating Flows

	D6 (1,900 rpm engine speed*)		D6 XE (1,700 rpm engine speed*)	
Implement Pump Maximum Flow	212 L/min	56 gal/min	212 L/min	56 gal/min
Steering Pump Maximum Flow	198 L/min	52 gal/min	240 L/min	63 gal/min
Fan Pump Flow at Maximum Fan (1,550 rpm)	42 L/min	11 gal/min	—	—
Fan Pump Flow at Maximum Fan (1,625 rpm)	—	—	44 L/min	12 gal/min

*Engine speed varies with load and travel speed. A high idle/low working load speed shown.

Hydraulic Controls – Maximum Operating Pressures

Implement Relief*	27 600 ± 500 kPa	4,000 ± 73 psi
Steering – D6 (89 cc pump)**		
Electronic Relief	42 500 ± 1000 kPa	6,168 ± 145 psi
System Maximum Relief	47 800 ± 1000 kPa	6,938 ± 145 psi
Steering – D6 XE (100 cc pump)***		
Electronic Relief	44 500 ± 1000 kPa	6,459 ± 145 psi
System Maximum Relief	47 800 ± 1000 kPa	6,938 ± 145 psi

*Implement relief pressure increased over prior model D6 tractors. Consult with your dealer prior to using older vintage or third party implements.

**The same differential steering system is used for both power trains. This system maintains full power to both tracks to provide best-in-class turning with a loaded blade.

***The D6 XE power train utilizes a larger steering pump and enhanced steering controls to provide more steering power, compared to the D6 power train, to turn larger loads and to improve maneuverability. This includes the ability to counter-rotate in gear.

Steering

The D6 XE power train provides up to a 45 percent steering radius reduction compared to the D6. The D6 XE offers in-gear counter rotation for increased maneuverability.

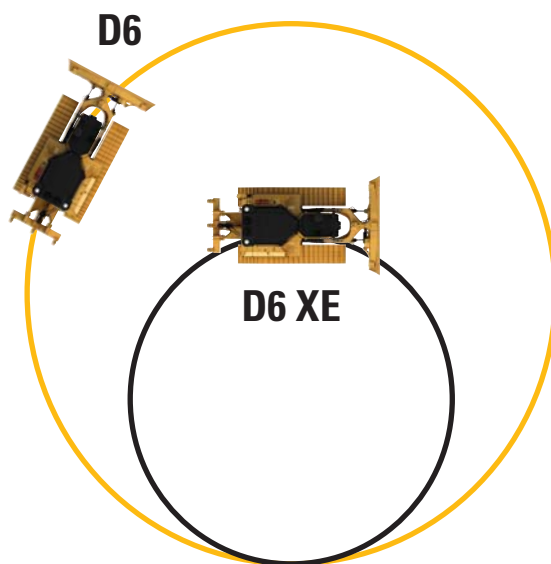

D6/D6 XE Track-Type Tractors Specifications

Configuration Tables – D6/D6 XE

Configuration	D6/D6 XE*	
Operating Weight**	22 000 kg	48,500 lb
Shipping Weight***	19 060 kg	42,020 lb
Ground Pressure (ISO 16754)	54 kPa	7.9 psi
Undercarriage (Standard)	42 Section with 7 Bottom Rollers	
1 Track Gauge	1.930 m	76 in
2 Width of Maximum Track Shoe	0.610 m	24 in
3 Width over Tracks	2.540 m	100 in
Width over Trunnions	2.692 m	106 in
4 Length of Track on Ground	2.964 m	116.7 in
Ground Contact Area (ISO 16754)	3.992 m ²	6188 in ²
Track Pitch	0.2028 m	7.9 in
Grouser Height (Moderate Service)	0.065 m	2.6 in
Ground Clearance	0.361 m	14.2 in
Oscillation at Front Idler	0.103 m	4.0 in
5 Machine Height****	3.172 m	124.9 in
6 Length of Machine without Blade	4.730 m	186.2 in

All dimensions above with Heavy Duty undercarriage with Moderate Service shoes of maximum width for configuration, 6 SU blade, and calculated per ISO 16754 unless otherwise specified.

*XE power train adds 0.7 kPa (0.1 psi) and 273 kg (600 lb) to the published ground pressure and weights.

**Operating weight includes blade, lubricants, coolant, full fuel tank, ROPS/FOPS cab, drawbar, and 75 kg (165 lb) operator.

***Shipping weight includes blade lift cylinders, lubricants, coolant, 10% fuel, ROPS/FOPS cab, and drawbar.

****Machine height from tip of grouser to top of Product Link™ Antenna. For sweeps, add 66 mm (2.6 in) to overall machine height. For forestry sweeps, add 122 mm (4.4 in). With Extreme Service Track Shoes add 12 mm (0.5 in). When Cat GRADE with 3D antennas are installed there is no addition to machine height.

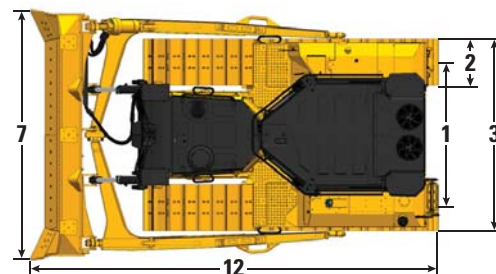
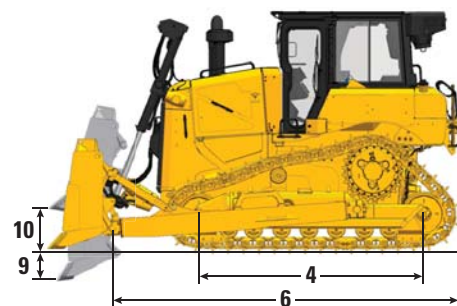
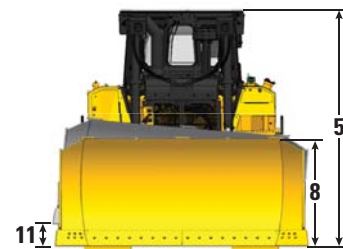

Blades

Configuration	6 SU		6 SU Landfill		6A	
Capacity (ISO 9246)	5.7 m ³	7.5 yd ³	11.2 m ³	14.6 yd ³	4.2 m ³	5.5 yd ³
7 Width across End Bits	3.312 m	10 ft 10.4 in	3.312 m	10 ft 10.4 in	4.389 m	14 ft 4.8 in
Width without End Bits	3.246 m	10 ft 7.8 in	3.246 m	10 ft 7.8 in	4.250 m	13 ft 11.3 in
Width across End Bits (Blade Angled)	N/A		N/A		3.982 m	13 ft 0.8 in
Width without End Bits (Blade Angled)	N/A		N/A		3.858 m	12 ft 7.9 in
Maximum Blade Angle	N/A		N/A		25 degrees	
8 Height	1.408 m	4 ft 7.4 in	2.027 m	6 ft 7.8 in	1.150 m	3 ft 9.3 in
9 Dig Depth	0.502 m	19.8 in	0.502 m	19.8 in	0.595 m	23.4 in
10 Lift Height	1.180 m	46.5 in	1.180 m	46.5 in	1.084 m	42.7 in
11 Maximum Tilt at Blade Corner	0.564 m	22.2 in	0.564 m	22.2 in	0.599 m	23.6 in
Maximum Tilt Angle	9.8 degrees		9.8 degrees		7.8 degrees	
Pitch Adjustment	±4.2 degrees		±4.2 degrees		N/A	
12 Length of Machine (Blade Straight)	5.436 m	17 ft 10.0 in	5.436 m	17 ft 10.0 in	5.377 m	17 ft 7.7 in
Length of Machine (Blade Angled)	N/A		N/A		6.418 m	21 ft 0.7 in
Weight (Blade)	1373 kg	3,027 lb	1592 kg	3,510 lb	1253 kg	2,762 lb
Weight (Blade and Push Arms)	2608 kg	5,750 lb	2827 kg	6,232 lb	3394 kg	7,842 lb

D6/D6 XE Track-Type Tractors Specifications

Configuration Tables – D6/D6 XE LGP (30 in)

Configuration	D6/D6 XE*	
Operating Weight**	22 740 kg	50,130 lb
Shipping Weight***	19 580 kg	43,165 lb
Ground Pressure (ISO 16754)	46 kPa	6.6 psi
Undercarriage (Standard)	42 Section with 7 Bottom Rollers	
1 Track Gauge	2.080 m	82 in
2 Width of Maximum Track Shoe	0.760 m	30 in
3 Width over Tracks	2.840 m	111.8 in
Width over Trunnions	2.994 m	117.9 in
4 Length of Track on Ground	2.964 m	116.7 in
Ground Contact Area (ISO 16754)	4.990 m ²	7,735 in ²
Track Pitch	0.2028 m	7.9 in
Grouser Height (Moderate Service)	0.065 m	2.6 in
Ground Clearance	0.361 m	14.2 in
Oscillation at Front Idler	0.100 m	3.9 in
5 Machine Height****	3.172 m	124.9 in
6 Length of Machine without Blade	4.730 m	186.2 in

All dimensions above with Heavy Duty undercarriage with Moderate Service shoes of maximum width for configuration, 6 SU blade, and calculated per ISO 16754 unless otherwise specified.

*XE power train adds 0.7 kPa (0.1 psi) and 273 kg (600 lb) to the published ground pressure and weights.

**Operating weight includes blade, lubricants, coolant, full fuel tank, ROPS/FOPS cab, drawbar, and 75 kg (165 lb) operator.

***Shipping weight includes blade lift cylinders, lubricants, coolant, 10% fuel, ROPS/FOPS cab, and drawbar.

****Machine height from tip of grouser to top of Product Link Antenna. For sweeps, add 66 mm (2.6 in) to overall machine height. For forestry sweeps, add 122 mm (4.4 in). With Extreme Service Track Shoes add 12 mm (0.5 in). When Cat GRADE with 3D antennas are installed there is no addition to machine height.

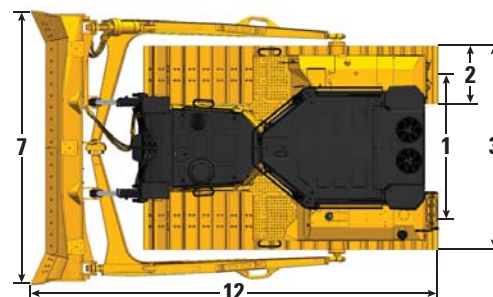
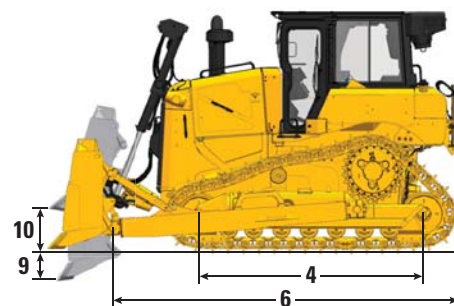
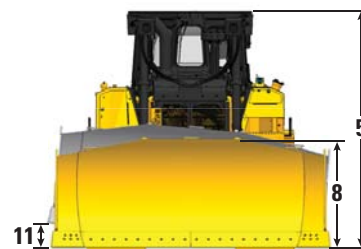

Blades

Configuration	6 SU LGP (30 in)		6 SU LGP (30 in) Landfill		6A LGP (30 in)	
Capacity (ISO 9246)	5.8 m ³	7.6 yd ³	12.3 m ³	16.1 yd ³	4.6 m ³	6.0 yd ³
7 Width across End Bits	3.613 m	11 ft 10.2 in	3.613 m	11 ft 10.2 in	4.735 m	15 ft 6.4 in
Width without End Bits	3.551 m	11 ft 7.8 in	3.551 m	11 ft 7.8 in	4.596 m	15 ft 1.0 in
Width across End Bits (Blade Angled)	N/A		N/A		4.295 m	14 ft 1.1 in
Width without End Bits (Blade Angled)	N/A		N/A		4.172 m	13 ft 8.3 in
Maximum Blade Angle	N/A		N/A		25 degrees	
8 Height	1.408 m	4 ft 7.4 in	2.027 m	6 ft 7.8 in	1.150 m	3 ft 9.3 in
9 Dig Depth	0.502 m	19.8 in	0.502 m	19.8 in	0.568 m	22.3 in
10 Lift Height	1.180 m	46.5 in	1.180 m	46.5 in	1.125 m	44.3 in
11 Maximum Tilt at Blade Corner	0.551 m	21.7 in	0.551 m	21.7 in	0.640 m	25.2 in
Maximum Tilt Angle	8.8 degrees		8.8 degrees		7.8 degrees	
Pitch Adjustment	±4.2 degrees		±4.2 degrees		N/A	
12 Length of Machine (Blade Straight)	5.436 m	17 ft 10.0 in	5.436 m	17 ft 10.0 in	5.448 m	17 ft 10.5 in
Length of Machine (Blade Angled)	N/A		N/A		6.561 m	21 ft 6.3 in
Weight (Blade)	1446 kg	3,188 lb	1700 kg	3,748 lb	1350 kg	2,976 lb
Weight (Blade and Push Arms)	2827 kg	6,232 lb	2973 kg	6,554 lb	3414 kg	7,527 lb

D6/D6 XE Track-Type Tractors Specifications

Configuration Tables – D6/D6 XE LGP (36 in)

Configuration	D6/D6 XE*	
Operating Weight**	23 866 kg	52,615 lb
Shipping Weight***	21 165 kg	46,660 lb
Ground Pressure (ISO 16754)	35 kPa	5.1 psi
Undercarriage (Standard)	45 Section with 8 Bottom Rollers	
1 Track Gauge	2.286 m	90 in
2 Width of Maximum Track Shoe	0.915 m	36 in
3 Width over Tracks	3.200 m	126.0 in
Width over Trunnions	3.491 m	137.4 in
4 Length of Track on Ground	3.247 m	127.8 in
Ground Contact Area (ISO 16754)	6.505 m ²	10,083 in ²
Track Pitch	0.2028 m	7.9 in
Grouser Height (Moderate Service)	0.065 m	2.6 in
Ground Clearance	0.411 m	16.2 in
Oscillation at Front Idler	0.116 m	4.6 in
5 Machine Height****	3.222 m	126.9 in
6 Length of Machine without Blade	5.040 m	198.4 in

All dimensions above with Heavy Duty undercarriage with Moderate Service shoes of maximum width for configuration, 6 S blade, and calculated per ISO 16754 unless otherwise specified.

*XE power train adds 0.7 kPa (0.1 psi) and 273 kg (600 lb) to the published ground pressure and weights.

**Operating weight includes blade, lubricants, coolant, full fuel tank, ROPS/FOPS cab, drawbar, and 75 kg (165 lb) operator.

***Shipping weight includes blade lift cylinders, lubricants, coolant, 10% fuel, ROPS/FOPS cab, and drawbar.

****Machine height from tip of grouser to top of Product Link Antenna. For sweeps, add 66 mm (2.6 in) to overall machine height. For forestry sweeps, add 122 mm (4.4 in). With Extreme Service Track Shoes add 12 mm (0.5 in). When Cat GRADE with 3D antennas are installed there is no addition to machine height.

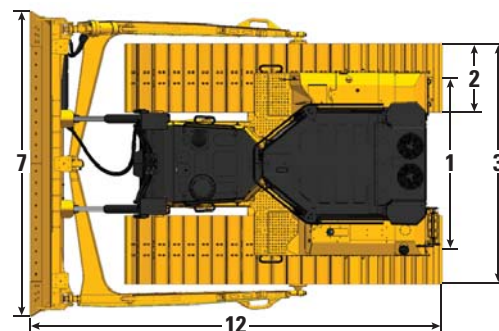
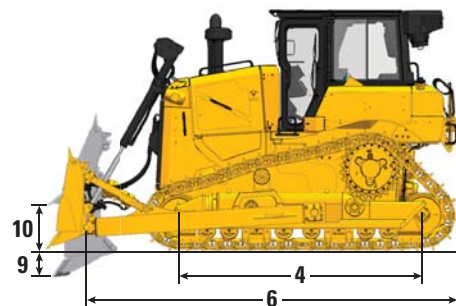
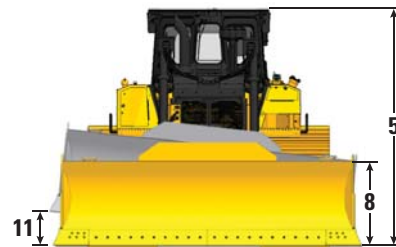

Blades

Configuration	6 S LGP (36 in)		6 S LGP (36 in) Landfill		6A LGP (36 in)	
Capacity (ISO 9246)	3.8 m ³	5.0 yd ³	9.40 m ³	12.3 yd ³	5.0 m ³	6.5 yd ³
7 Width across End Bits	4.063 m	13 ft 4 in	4.063 m	13 ft 4 in	5.100 m	16 ft 8.8 in
Width without End Bits	3.917 m	12 ft 10.2 in	3.917 m	12 ft 10.2 in	4.961 m	16 ft 3.3 in
Width across End Bits (Blade Angled)	N/A		N/A		4.626 m	15 ft 2.1 in
Width without End Bits (Blade Angled)	N/A		N/A		4.502 m	14 ft 9.2 in
Maximum Blade Angle	N/A		N/A		25 degrees	
8 Height	1.108 m	3 ft 7.6 in	1.767 m	3 ft 7.6 in	1.150 m	3 ft 9.3 in
9 Dig Depth	0.600 m	1 ft 11.6 in	0.600 m	1 ft 11.6 in	0.719 m	28.3 in
10 Lift Height	1.080 m	3 ft 6.5 in	1.080 m	3 ft 6.5 in	1.173 m	46.2 in
11 Maximum Tilt at Blade Corner	0.500 m	1 ft 7.7 in	0.500 m	1 ft 7.7 in	0.689 m	27.1 in
Maximum Tilt Angle	8.8 degrees		8.8 degrees		7.8 degrees	
Pitch Adjustment	±4.2 degrees		±4.2 degrees		N/A	
12 Length of Machine (Blade Straight)	5.483 m	17 ft 11.9 in	5.483 m	17 ft 11.9 in	5.960 m	19 ft 6.6 in
Length of Machine (Blade Angled)	N/A		N/A		6.996 m	22 ft 10.3 in
Weight (Blade)	1220 kg	2,690 lb	1432 kg	3,157 lb	1453 kg	3,203 lb
Weight (Blade and Push Arms)	2370 kg	5,225 lb	2582 kg	5,692 lb	3618 kg	7,976 lb

D6/D6 XE Track-Type Tractors Specifications

Configuration Tables – D6/D6 XE VPAT

Configuration	D6/D6 XE*	
Operating Weight**	22 240 kg	49,030 lb
Shipping Weight***	20 500 kg	45,195 lb
Ground Pressure (ISO 16754)	49 kPa	7.1 psi
Undercarriage (Standard)	45 Section with 8 Bottom Rollers	
1 Track Gauge	2.080 m	82 in
2 Width of Maximum Track Shoe	0.610 m	24 in
3 Width over Tracks	2.690 m	105.9 in
4 Length of Track on Ground	3.247 m	127.8 in
Ground Contact Area (ISO 16754)	4.473 m ²	6,933 in ²
Track Pitch	0.2028 m	7.9 in
Grouser Height (Moderate Service)	0.065 m	2.6 in
Ground Clearance	0.422 m	16.6 in
Oscillation at Front Idler	0.112 m	4.4 in
5 Machine Height****	3.222 m	126.9 in
6 Length of Machine without Blade	5.134 m	202.1 in

All dimensions above with Heavy Duty undercarriage with Moderate Service shoes of maximum width for configuration, VPAT blade, and calculated per ISO 16754 unless otherwise specified.

*XE power train adds 0.7 kPa (0.1 psi) and 273 kg (600 lb) to the published ground pressure and weights.

**Operating weight includes blade, lubricants, coolant, full fuel tank, ROPS/FOPS cab, drawbar, and 75 kg (165 lb) operator.

***Shipping weight includes blade lift cylinders, C-frame, lubricants, coolant, 10% fuel, ROPS/FOPS cab, and drawbar.

****Machine height from tip of grouser to top of Product Link Antenna. For sweeps, add 66 mm (2.6 in) to overall machine height. For forestry sweeps, add 122 mm (4.4 in). With Extreme Service Track Shoes add 12 mm (0.5 in). When Cat GRADE with 3D antennas are installed there is no addition to machine height.

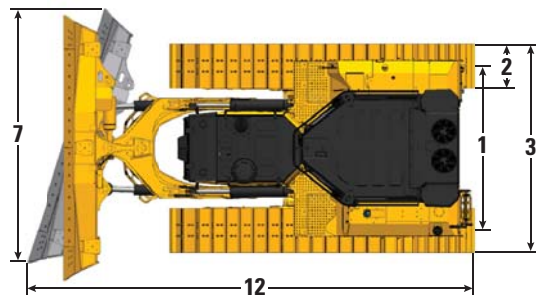
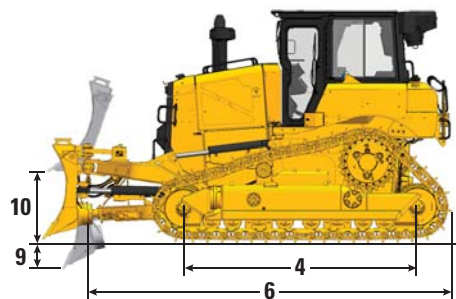
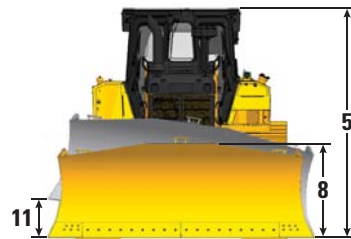

Blade

Configuration	6 VPAT	
Capacity (ISO 9246)	4.1 m ³	5.4 yd ³
7 Width across End Bits	3.680 m	12 ft 0.9 in
Width without End Bits	3.570 m	11 ft 8.6 in
Width across End Bits (Blade Angled)	3.363 m	11 ft 0.4 in
Width without End Bits (Blade Angled)	3.266 m	10 ft 8.6 in
Maximum Blade Angle	24.1 degrees	
8 Height	1.312 m	4 ft 3.7 in
9 Dig Depth	0.698 m	27.5 in
10 Lift Height	1.131 m	44.5 in
11 Maximum Tilt at Blade Corner	0.576 m	22.7 in
Maximum Tilt Angle	9 degrees	
Pitch Adjustment	+3.1/-2.9 degrees	
12 Length of Machine (Blade Straight)	5.662 m	18 ft 6.9 in
Length of Machine (Blade Angled)	6.365 m	20 ft 10.6 in
Weight (Blade)	1414 kg	3,117 lb

D6/D6 XE Track-Type Tractors Specifications

Configuration Tables – D6/D6 XE LGP VPAT (30 in)

Configuration	D6/D6 XE*	
Operating Weight**	22 975 kg	50,650 lb
Shipping Weight***	21 125 kg	46,575 lb
Ground Pressure (ISO 16754)	40 kPa	5.8 psi
Undercarriage (Standard)	46 Section with 8 Bottom Rollers	
Undercarriage (Optional)	46 Section with 10 Bottom Rollers	
1 Track Gauge	2.286 m	90 in
2 Width of Maximum Track Shoe	0.760 m	30 in
3 Width over Tracks	3.046 m	119.9 in
4 Length of Track on Ground	3.355 m	132.1 in
Ground Contact Area (ISO 16754)	5.591 m ²	8,666 in ²
Track Pitch	0.2028 m	7.9 in
Grouser Height (Moderate Service)	0.065 m	2.6 in
Ground Clearance	0.390 m	15.4 in
Oscillation at Front Idler	0.121 m	4.8 in
5 Machine Height****	3.222 m	126.9 in
6 Length of Machine without Blade	5.134 m	202.1 in

All dimensions above with Heavy Duty undercarriage with Moderate Service shoes of maximum width for configuration, VPAT blade, and calculated per ISO 16754 unless otherwise specified.

*XE power train adds 0.7 kPa (0.1 psi) and 273 kg (600 lb) to the published ground pressure and weights.

**Operating weight includes blade, lubricants, coolant, full fuel tank, ROPS/FOPS cab, drawbar, and 75 kg (165 lb) operator.

***Shipping weight includes blade lift cylinders, C-frame, lubricants, coolant, 10% fuel, ROPS/FOPS cab, and drawbar.

****Machine height from tip of grouser to top of Product Link Antenna. For sweeps, add 66 mm (2.6 in) to overall machine height. For forestry sweeps, add 122 mm (4.4 in). With Extreme Service Track Shoes add 12 mm (0.5 in). When Cat GRADE with 3D antennas are installed there is no addition to machine height.

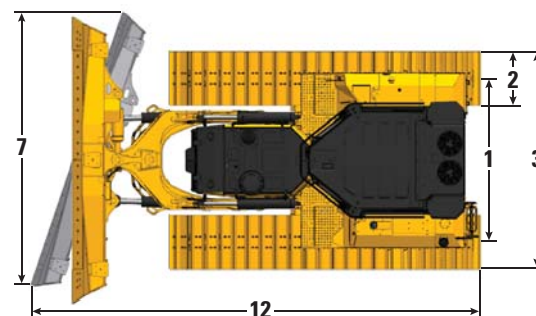
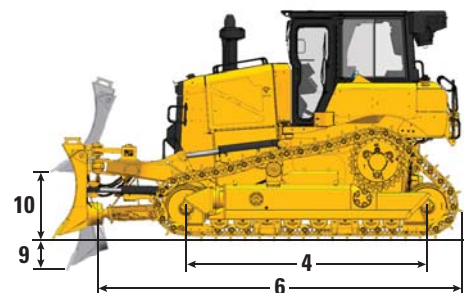
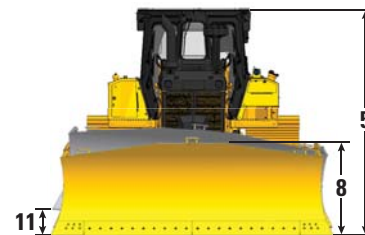

Blade

Configuration	6 VPAT LGP (30 in)	
Capacity (ISO 9246)	4.5 m ³	5.9 yd ³
7 Width across End Bits	4.000 m	13 ft 1.5 in
Width without End Bits	3.890 m	12 ft 9.1 in
Width across End Bits (Blade Angled)	3.655 m	11 ft 11.9 in
Width without End Bits (Blade Angled)	3.554 m	11 ft 7.9 in
Maximum Blade Angle	24.1 degrees	
8 Height	1.312 m	4 ft 3.7 in
9 Dig Depth	0.698 m	27.5 in
10 Lift Height	1.131 m	44.5 in
11 Maximum Tilt at Blade Corner	0.625 m	24.6 in
Maximum Tilt Angle	9 degrees	
Pitch Adjustment	+3.1/-2.9 degrees	
12 Length of Machine (Blade Straight)	5.662 m	18 ft 6.9 in
Length of Machine (Blade Angled)	6.430 m	21 ft 1.1 in
Weight (Blade)	1516 kg	3,342 lb

D6/D6 XE Track-Type Tractors Specifications

Configuration Tables – D6/D6 XE LGP VPAT (36 in)

Configuration	D6/D6 XE*	
Operating Weight**	23 530 kg	51,875 lb
Shipping Weight***	21 580 kg	47,575 lb
Ground Pressure (ISO 16754)	35 kPa	5.0 psi
Undercarriage (Standard)	46 Section with 8 Bottom Rollers	
Undercarriage (Optional)	46 Section with 10 Bottom Rollers	
1 Track Gauge	2.39 m	94 in
2 Width of Maximum Track Shoe	0.915 m	36 in
3 Width over Tracks	3.305 m	130.1 in
4 Length of Track on Ground	3.355 m	132.1 in
Ground Contact Area (ISO 16754)	6.709 m ²	9,510 in ²
Track Pitch	0.2028 m	7.9 in
Grouser Height (Moderate Service)	0.065 m	2.6 in
Ground Clearance	0.383 m	15.1 in
Oscillation at Front Idler	0.121 m	4.8 in
5 Machine Height****	3.222 m	126.9 in
6 Length of Machine without Blade	5.134 m	202.1 in

All dimensions above with Heavy Duty undercarriage with Moderate Service shoes of maximum width for configuration, VPAT blade, and calculated per ISO 16754 unless otherwise specified.

*XE power train adds 0.7 kPa (0.1 psi) and 273 kg (600 lb) to the published ground pressure and weights.

**Operating weight includes blade, lubricants, coolant, full fuel tank, ROPS/FOPS cab, tow point, and 75 kg (165 lb) operator.

***Shipping weight includes blade lift cylinders, C-frame, lubricants, coolant, 10% fuel, ROPS/FOPS cab, and tow point.

****Machine height from tip of grouser to top of Product Link Antenna. For sweeps, add 66 mm (2.6 in) to overall machine height. For forestry sweeps, add 122 mm (4.4 in). With Extreme Service Track Shoes add 12 mm (0.5 in). When Cat GRADE with 3D antennas are installed there is no addition to machine height.

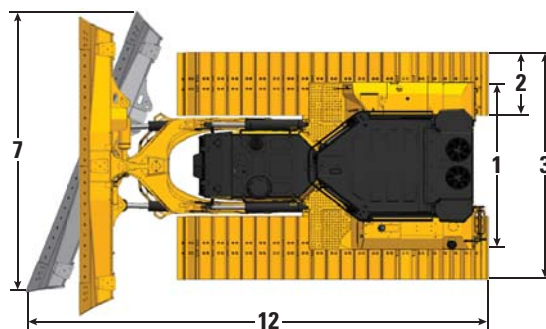
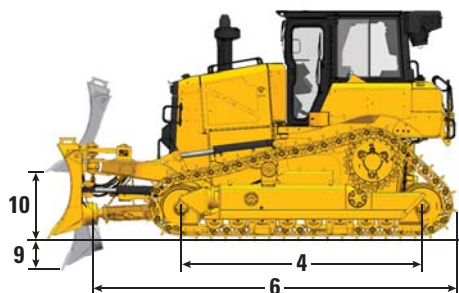
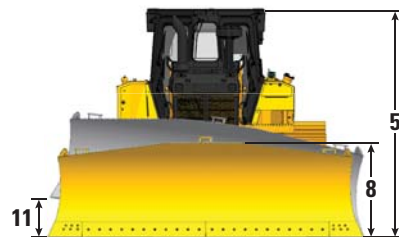

Blade

Configuration	6 VPAT LGP (36 in)	
Capacity (ISO 9246)	4.86 m ³	6.5 yd ³
7 Width across End Bits	4.340 m	14 ft 2.9 in
Width without End Bits	4.230 m	13 ft 10.5 in
Width across End Bits (Blade Angled)	3.966 m	13 ft 0.1 in
Width without End Bits (Blade Angled)	3.868 m	12 ft 8.3 in
Maximum Blade Angle	24.1 degrees	
8 Height	1.312 m	4 ft 3.7 in
9 Dig Depth	0.698 m	27.5 in
10 Lift Height	1.131 m	44.5 in
11 Maximum Tilt at Blade Corner	0.684 m	26.9 in
Maximum Tilt Angle	9 degrees	
Pitch Adjustment	+3.1/-2.9 degrees	
12 Length of Machine (Blade Straight)	5.662 m	18 ft 6.9 in
Length of Machine (Blade Angled)	6.500 m	21 ft 3.9 in
Weight (Blade)	1617 kg	3,565 lb

D6/D6 XE Track-Type Tractors Specifications

Configuration Tables – D6/D6 XE LGP Folding VPAT (30 in) – EU only

Configuration	D6/D6 XE*	
Operating Weight**	22 360 kg	49,295 lb
Shipping Weight***	19 775 kg	43,595 lb
Ground Pressure (ISO 16754)	45 kPa	6.5 psi
Undercarriage (Standard)	46 Section with 8 Bottom Rollers	
Undercarriage (Optional)	46 Section with 10 Bottom Rollers	
1 Track Gauge	2.286 m	90 in
2 Width of Standard Track Shoe****	0.660 m	26 in
Optional Maximum Track Shoe****	0.760 m	30 in
3 Width over Tracks	2.946 m	116.0 in
4 Length of Track on Ground	3.355 m	132.1 in
Ground Contact Area (ISO 16754)	4.845 m ²	7,510 in ²
Track Pitch	0.2028 m	7.9 in
Grouser Height (Moderate Service)	0.065 m	2.6 in
Ground Clearance	0.390 m	15.4 in
Oscillation at Front Idler	0.121 m	4.8 in
5 Machine Height*****	3.222 m	126.9 in
6 Length of Machine without Blade	5 134 m	202.1 in

All dimensions above with Heavy Duty undercarriage with Moderate Service shoes of standard width for configuration, Foldable VPAT blade, and calculated per ISO 16754 unless otherwise specified.

*XE power train adds 0.7 kPa (0.1 psi) and 273 kg (600 lb) to the published ground pressure and weights.

**Operating weight includes blade, lubricants, coolant, full fuel tank, ROPS/FOPS cab, drawbar, and 75 kg (165 lb) operator.

***Shipping weight includes blade lift cylinders, C-frame, lubricants, coolant, 10% fuel, ROPS/FOPS cab, and drawbar.

****Standard track shoe width ensures 3.0 m shipping width with blade folded. Optional 30 inch track shoes provide lower ground pressure of 42 kPa (6.1 psi). Increases shipping width to 3.046 m (120.0 in).

*****Machine height from tip of grouser to top of Product Link Antenna. For sweeps, add 66 mm (2.6 in) to overall machine height. For forestry sweeps, add 122 mm (4.4 in). With Extreme Service Track Shoes add 12 mm (0.5 in). When Cat GRADE with 3D antennas are installed there is no addition to machine height.

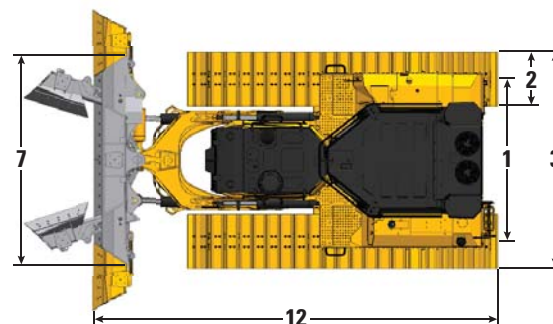
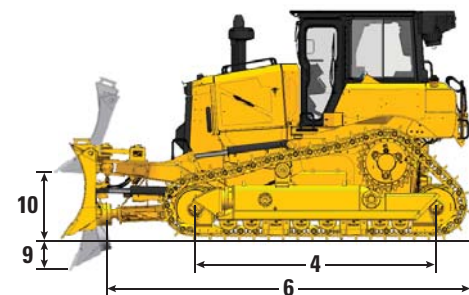
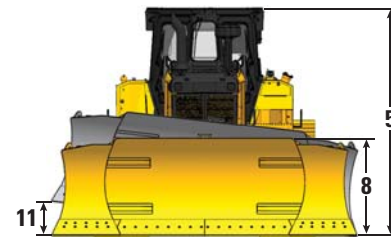

Blade

Configuration	6 VPAT LGP Folding (30 in)	
Capacity (ISO 9246)	5.2 m ³	6.8 yd ³
7 Width across End Bits	4.229 m	13 ft 10.5 in
Width without End Bits	4.115 m	13 ft 6.0 in
Width of Folded Blade	2.960 m	9 ft 8.5 in
Maximum Blade Angle	24.1 degrees	
8 Height	1.312 m	4 ft 3.7 in
9 Dig Depth	0.698 m	27.5 in
10 Lift Height	1.131 m	44.5 in
11 Maximum Tilt at Blade Corner	0.659 m	26.0 in
Maximum Tilt Angle	9 degrees	
Pitch Adjustment	+3.1/-2.9 degrees	
12 Length of Machine (Blade Straight)	5.662 m	18 ft 6.9 in
Length of Machine (Blade Angled)	6.643 m	21 ft 9.5 in
Weight (Blade)	2254 kg	4,969 lb

D6/D6 XE Track-Type Tractors Specifications

Dimensions – Rear Attachments

Add the following to the total length of the machine when these rear attachments are installed.

		Winch		Ripper		Drawbar or Counterweight*		Waste Striker Box	
Push Arm and Angle Dozers	D6, D6 LGP (30 in)	441 mm	17.4 in	1179 mm	46.4 in	249 mm	9.8 in	478 mm	18.8 in
	D6 LGP (36 in)	416 mm	16.4 in	1154 mm	45.4 in	224 mm	8.8 in	453 mm	17.8 in
VPAT Dozers		416 mm	16.4 in	1154 mm	45.4 in	224 mm	8.8 in	453 mm	17.8 in

*Drawbar weight 119 kg (262 lb), 331 kg (730 lb) for each counterweight slab. The new D6 dozer design provides improved balance. Counterweights are only recommended with heavier aftermarket blades.

Ripper

Type	Fixed Parallelogram	
Number of Pockets	3	
1 Ramp Angle	31 degrees	
2 Maximum Clearance Raised (under tip)	664 mm	26.1 in
3 Maximum Penetration	571 mm	22.5 in
4 Pocket Spacing	1000 mm	39.4 in
5 Shank Gauge	2000 mm	78.8 in
Shank Section	74 mm × 175 mm	2.9 in × 6.9 in
6 Overall Beam Width	2190 mm	86 in
Beam Cross Section	219 mm × 304 mm	8.8 in × 12 in
Maximum Penetration Force*	68.8 kN	15,470 lbf
Pryout Force	126 kN	28,350 lbf
Ripper Weight		
With One Shank	1550 kg	3,417 lb
Each Additional Shank	73 kg	161 lb

Specifications based on D6 tractor configuration with Heavy Duty undercarriage, MS shoes, and straight ripper shanks.

*May vary based on configuration and machine weight.

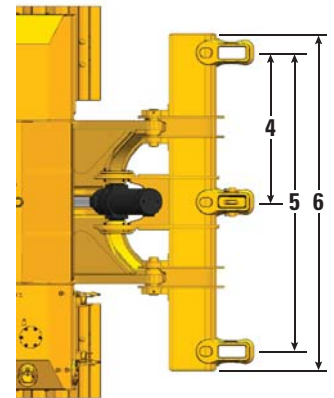
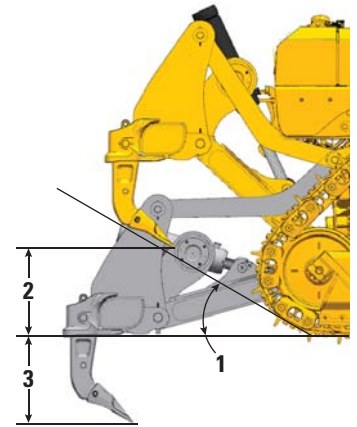

D6/D6 XE Track-Type Tractors Specifications

Winches

The D6 and D6 XE expand industry-leading winch capability with the introduction of available high pressure (27 600 kPa/4,000 psi) hydraulics capable of powering high performance hydraulic winches. These winches provide exceptional controllability for applications that require precise load placement. The D6 retains compatibility with PTO-driven winches for maximum power and efficiency. Winches of both styles are available from Caterpillar for factory or dealer installation, and integrate with the tractor's electronic and control system.

Tractor Model	D6		D6 and D6 XE	
Winch Model	PA56 (Low Speed)		PA85	
Winch Drive	Mechanical		Hydraulic	
Control	Electrical		Electrical	
Operating Weight*	1582 kg	3,487 lb	1530 kg	3,374 lb
Oil Capacity	43.5 L	11.5 gal	19 L	5 gal
Increased Tractor Length				
Standard/LGP	516 mm	20.4 in	516 mm	20.4 in
LGP (36 in)	365 mm	14.4 in	365 mm	14.4 in
Drum Diameter	254 mm	10 in	254 mm	10 in
Rope Diameter				
Recommended	22 mm	0.88 in	22 mm	0.88 in
Optional	25 mm	1 in	25 mm	1 in
Drum Working Capacity				
22 mm (0.88 in)	55 m	180 ft	55 m	180 ft
25 mm (1.0 in)	50 m	163 ft	50 m	163 ft
Cable Ferrule Size (O.D. × Length)	54 mm × 67 mm	2.1 in × 2.6 in	54 mm × 67 mm	2.1 in × 2.6 in
Maximum Bare Drum				
Line Pull**	40 700 kg	89,800 lb	40 000 kg	88,000 lb
Line Speed***	18 m/min	58 ft/min	27 m/min	89 ft/min
Maximum Full Drum****				
Line Pull**	34 600 kg	76,300 lb	24 000 kg	52,800 lb
Line Speed***	31 m/min	103 ft/min	44 m/min	145 ft/min

*Operating Weight includes winch, mounting hardware, oil, and recommended wire rope.

**Maximum line pull is lesser of calculated line pull at maximum tractor PTO output torque/hydraulic power or catalog breaking strength of maximum optional size new IWRC IPS wire rope.

***Maximum line speed is calculated no-load line speed at maximum tractor engine PTO output speed or maximum hydraulic power.

****Full drum as defined by SAE J1158.

D6/D6 XE Track-Type Tractors Specifications

Track Shoes

Available as Heavy Duty or SystemOne™. Some track shoes not available in all regions. Please consult your Cat dealer for details.

	Moderate Service	Extreme Service	Extreme Service Trapezoidal	Self-Cleaning	Quad/Quad Ready
D6/D6 XE – 42 Link					
560 mm (22 in)	✓	✓			
610 mm (24 in)	✓	✓	✓		
D6 LGP/D6 XE LGP – 42 Link					
610 mm (24 in)	✓	✓	✓		
760 mm (30 in)	✓	✓	✓		
D6 LGP/D6 XE LGP (36 in) – 45 Link					
760 mm (30 in)	✓	✓	✓		
915 mm (36 in)	✓	✓	✓		HDXL only
1000 mm (39 in)				HDXL only	
D6 VPAT/D6 XE VPAT – 45 Link					
610 mm (24 in)	✓	✓	✓		
D6 LGP VPAT/D6 XE LGP VPAT – 46 Link					
610 mm (24 in)	✓	✓	✓		
660 mm (26 in)	EU only				
760 mm (30 in)	✓	✓	✓		
D6 LGP VPAT/D6 XE LGP VPAT (36 in) – 46 Link					
760 mm (30 in)	✓	✓	✓		
915 mm (36 in)	✓	✓	✓		HDXL only

Fluid/Refill Capacities

Fuel Tank	341 L	90 gal
DEF Tank	28 L	7.4 gal
Cooling System – D6	63 L	16.6 gal
Cooling System – D6 XE	77 L	20.3 gal
Engine Crankcase	24.5 L	6.5 gal
Power Train Oil – D6	148 L	39.1 gal
Power Train Oil – D6 XE	210 L	55.5 gal
Final Drives (each)	18.2 L	4.8 gal
Roller Frames (each)	65-85 L	17.2-22.5 gal
Pivot Shaft Compartment	2.8 L	0.74 gal
Hydraulic Tank Oil	60 L	15.8 gal
Hydraulic System	77 L	20.3 gal

Waste Handlers

	D6/D6 XE*		D6/D6 XE* LGP (30 in)		D6/D6 XE* LGP (36 in)	
Operating Weight	23 662 kg	52,166 lb	23 927 kg	52,751 lb	25 253 kg	55,674 lb
Shipping Weight**	21 072 kg	46,456 lb	21 229 kg	46,803 lb	22 823 kg	50,317 lb

Waste Handler operating weight varies by options selected. Published weights for each configuration include Heavy Duty waste undercarriage with shoes of maximum width, waste blade, fuel tank guards, guarded final drives, high debris cab, chassis bars, striker box, full fuel tank, lubricants, and 75 kg (165 lb) operator.

*XE power train adds 273 kg (600 lb) to the published weights.

**Shipping weight is calculated based on operating weight, minus blade/push arms, less operator, and 10% fuel.

D6/D6 XE Track-Type Tractors Specifications

Air Conditioning System

The air conditioning system on this machine contains the fluorinated greenhouse gas refrigerant R134a (Global Warming Potential = 1430). The system contains 1.36 kg of refrigerant which has a CO₂ equivalent of 1.946 metric tonnes.

Advanced Cabin Filtration

Operator Cabin

- Distributed HVAC ducting with automatic temperature control and blower speed provides ultimate operator comfort with less user input.
- Reduced maintenance of the condenser core with automatic reversing fans.
- Cat Advanced Cabin Filtration is standard.

Cat Advanced Cabin Filtration

- Operator protection from respirable particulate (0.3-10 micron size).
- Sustainably pressurized cab (US Silica compliant).
- Reduced maintenance with longer life, high efficiency filters.
- Protection for all cabin components: electronics, etc.
- Helps meet U.S. Occupational Safety and Health Administration Silica Rule Table 1 requirements for operator cabs.
- Multi-tiered filter offerings for optional efficiency upgrades. Contact Cat dealer for availability.
 - MERV 16 – Standard Equipment
 - HEPA
 - Activated Carbon + HEPA
 - ABEK1 + HEPA

Standards

Rollover Protective Structure (ROPS)/ Falling Object Protective Structure (FOPS)

- ROPS meets ISO 3471:2008, FOPS meets ISO 3449:2005 Level II.

Brakes

- Brakes meet the International Standard ISO 10265:2008.

Cab

Meets appropriate standards as listed below.

- The average dynamic spectator sound power level when “ISO 6395:2008” is used to measure the value for a machine is shown below. The measurement was conducted at 70% of the maximum engine cooling fan speed. The sound level may vary at different engine cooling fan speeds.

NOTE: The dynamic sound power level uncertainty is ± 2 dB(A).

D6	111 dB(A)
D6 XE	109 dB(A)

- The average dynamic operator sound pressure level when “ISO 6396:2008” is used to measure the value for an enclosed cab is shown below. The measurement was conducted at 70% of the maximum engine cooling fan speed. The sound level may vary at different engine cooling fan speeds. The cab was properly installed and maintained. The measurement was conducted with the cab doors and the cab windows closed.

NOTE: The dynamic operator sound pressure level uncertainty is ± 2 dB(A).

D6	76 dB(A)
D6 XE	73 dB(A)

- Hearing protection may be needed when the machine is operated with an open operator station for extended periods, in a noisy environment, or with a cab that is not properly maintained.
- Sound level information for machines in European Union countries and in countries that adopt the “European Union Directives” is shown below. If equipped, the certification label is used to verify the environmental sound certification of the machine to the requirements of the European Union. The value that is listed on the label indicates the guaranteed exterior sound power level (L_{WA}) at the time of manufacture for the conditions that are specified in “2000/14/EC.”

D6	111 dB(A)
D6 XE	111 dB(A)

D6/D6 XE Standard and Optional Equipment

Standard and Optional Equipment

Standard and optional equipment may vary. Consult your Cat dealer for details.

	Standard	Optional		Standard	Optional
POWER TRAIN			OPERATOR ENVIRONMENT		
Fully-automatic 4-speed Transmission with Lock Up Clutch (LUC) torque divider	D6		Cab (STD), Fully Redesigned with Integrated ROPS and FOPS, single pane door glass, sliding windows, with Cat Advanced Cabin Filtration	✓	
XE Electric Drive Power Train	D6 XE		Cab (High Debris), Fully Redesigned with Integrated ROPS and FOPS, impact resistant polycarbonate doors, solid side windows for improved sealing, powered precleaner with Cat Advanced Cabin Filtration for improved performance and filter life		✓
Differential Steering System	✓		Cab (Forestry), Fully Redesigned with Integrated ROPS and FOPS, impact resistant polycarbonate doors, sliding windows, with Cat Advanced Cabin Filtration		✓
Cat C9.3B diesel engine with turbo, with engine mounted aftertreatment to meet U.S. EPA Tier 4 Final, EU Stage V, Korea Tier 4 Final emission standards	✓		Full-color 254 mm (10 inch) liquid crystal touch screen display	✓	
Cat C9.3B diesel engine with thermal shield and liquid cooled turbo, with engine mounted aftertreatment to meet U.S. EPA Tier 4 Final, EU Stage V, Korea Tier 4 Final emission standards		✓	Integrated rearview camera	✓	
Engine air precleaner with dust ejection	✓		Adjustable operator controls/armrests	✓	
Engine air precleaner with dust ejection and screen for high debris applications		✓	Cloth seat with mechanical adjustable lumbar support	✓	
Double reduction planetary final drives	✓		Deluxe leather heated/ventilated seat with electronic adjustable lumbar support		✓
Double reduction planetary final drives, guarded		✓	Cab mounted modular HVAC system with automatic reversing fans. Automatic temperature and blower control with distributed ducting.	✓	
Automatic ether starting aid	✓		Viscous cab mounts for improved ride	✓	
Electric fuel priming pump	✓		Entertainment radio with Bluetooth® and microphone	✓	
Electronic parking brake	✓		USB and AUX ports	✓	
Engine air filter with electronic service indicator	✓		Glove box (removed if Cat GRADE with 3D is selected)	✓	
Fuel water separator with electronic service indicator	✓		Enhanced Cab Storage Solutions	✓	
Jacket water heater, 110V OR 220V based on sales region	✓		Window shades (front and door)*		✓
Diesel Exhaust Fluid (DEF) System – Electronic fill indicator, heated lines/tank	✓		Sound suppressed floor plates with adjustable foot pegs	✓	
CAT CONNECT TECHNOLOGY			Quick opening floor plate arrangement with sound suppression and adjustable foot pegs*		✓
Slope Indicate	✓		Fifth percentile operator floor plate arrangement*		✓
Stable Blade	✓		Screen ready, side and rear	✓	
Attachment Ready Option (ARO)	✓		Operator presence switch	✓	
Cat GRADE with Slope Assist™	✓				
Cat GRADE with 3D		✓			
Product Link, cellular PLE641	✓				
Product Link Elite PLE631 – dual cellular/satellite		✓			

*Please check with your Cat dealer for availability dates.

(continued on next page)

D6/D6 XE Standard and Optional Equipment

Standard and Optional Equipment *(continued)*

Standard and optional equipment may vary. Consult your Cat dealer for details.

	Standard	Optional		Standard	Optional
UNDERCARRIAGE			HYDRAULICS		
Structurally improved track roller frame designed to allow conversion between HD and S1	✓		Load sensing hydraulics – dozer lift and tilt	✓	
Undercarriage with 7 or 8 bottom rollers (configuration dependent)	✓		Independent steering hydraulics	✓	
Undercarriage with 10 bottom rollers for fine grading applications		✓	Ripper ready rear hydraulics	D6	
Waste undercarriage		HD UC only	Ripper and winch ready rear hydraulics	D6 XE	D6
Partially guided undercarriage		✓	Single axis ripper control	✓	
Fully guided undercarriage		✓	Dual axis ripper/winch control		✓
Heavy Duty (HDXL with DuraLink™)	✓		Hydraulic automatically reversing, zero speed capable cooling fan	✓	
SystemOne track		✓	Electronic Hydraulic lockout switch	✓	
Moderate service track shoes (see chart on page 13)	✓		ELECTRICAL		
Extreme service track shoes (see chart on page 13)		✓	Lights – 6 LED	✓	
Carrier roller	✓		Premium lights – 12 LED for 360 degree light coverage		✓
Hydraulically adjustable track	✓		Backup alarm	✓	
Replaceable sprocket rim segments	✓		Integrated beacon warning light (does not impact shipping height)		✓
BLADES			Brushless alternator	✓	
Semi-Universal, ARO mounts		✓	Brushless alternator, ducted for high debris applications		✓
Semi-Universal, LGP with ARO mounts		✓	Communication radio ready	✓	
Semi-Universal, Waste		✓	Converter: two 10 Amp, 12V outlets	✓	
Semi-Universal, LGP Waste		✓	Diagnostic connector	✓	
Straight blade, LGP with ARO mounts		✓	Forward warning horn	✓	
Straight blade, LGP Waste		✓	Fuse panel and main power relay located inside cab	✓	
VPAT, ARO mounts		✓			
VPAT, LGP with ARO mounts		✓			
VPAT, LGP (36 in) with ARO mounts		✓			
Foldable VPAT, LGP with ARO mounts		EU only			
Angle blade		NA only			
Caterpillar Performance cutting edges		Dealer only			

(continued on next page)

D6/D6 XE Standard and Optional Equipment

Standard and Optional Equipment (continued)

Standard and optional equipment may vary. Consult your Cat dealer for details.

	Standard	Optional		Standard	Optional
SERVICE AND MAINTENANCE			ATTACHMENTS		
30-minute cab removal	✓		Drawbar	✓	
Ecology drains	✓		High lift multi-shank ripper with straight or curved shanks		✓
Ecology drains with high speed oil power train and engine oil change		✓	Lightweight rear tow point		✓
Ground level service center with remote electrical disconnect, access light, secondary shutdown switch and hour meter	✓		Striker bar box		✓
Fuel tank, 341 L (90 gal)	✓		Counterweights (not recommended unless using heavier aftermarket blades)		✓
Fuel tank, 341 L (90 gal), fast fill ready	D6 XE	D6	PACCAR PA56 winch, low speed PTO		D6
Wiggins style fast fill nozzle		✓	PACCAR PA85 winch, variable speed hydraulic		✓
Mounting provision for grease gun and fire extinguisher	✓		PACCAR PA56 winch, standard speed PTO		D6 Dealer only
Perforated radiator doors, louvered and hinged	✓		Allied H6H winch, variable speed hydraulic		Dealer only
Rear access ladder	✓		Fairlead Assembly; 3-roller, fits PA55, PA56, and PA85 winches		✓
Refilling fuel pump		EU only	Retrofit kit (4th roller); fits PA55, PA56, and PA85 winches		✓
Removable engine enclosures, perforated and hinged, with under hood work light	✓		GUARDING AND SCREENS		
Removable engine enclosures, sound suppressed and hinged, with under hood work light		EU only	Bottom guards	✓	
S·O·S SM sampling ports	✓		Heavy duty sealed bottom guards		Push Arm only
Shovel holder	✓		Heavy duty sealed quick access bottom guards*		Push Arm only
Maintenance free equalizer bar	✓		Standard duty grab handles	✓	
Certified ISO 14567 tie off points (3)	✓		Heavy duty grab handles		✓
Vandalism protection for fluid compartments and battery box	✓		Open Sweeps guarding		✓
Dedicated shipping tie downs, rear	✓		Forestry Sweeps guarding with full canopy		✓
Shipping tie downs, front bracket		EU only	Hinged rear screen		✓
BATTERIES, STARTERS, ALTERNATORS AND FLUIDS			Hinged side screens		✓
150 Amp alternator	✓		Fuel tank guard (with or without fast fill)		✓
150 Amp ducted alternator		✓	Guards for premium lights, front and side		✓
Heavy duty batteries, two maintenance-free 12V (1,400 CCA) (24V system)	✓		Machine seals for high debris		✓
Heavy duty, 24V starter	✓		Front and rear striker bars		Dealer only
Extended Life Engine coolant, -37° C (-35° F)	✓		*Please check with your Cat dealer for availability dates.		
Extended Life Arctic engine coolant, -51° C (-60° F)		✓			
Bio hydraulic oil, -37° C (-35° F)		EU only			

For more complete information on Cat products, dealer services, and industry solutions, visit us on the web at www.cat.com

© 2018 Caterpillar
All rights reserved

Materials and specifications are subject to change without notice. Featured machines in photos may include additional equipment. See your Cat dealer for available options.

CAT, CATERPILLAR, LET'S DO THE WORK, their respective logos, "Caterpillar Yellow", the "Power Edge" trade dress as well as corporate and product identity used herein, are trademarks of Caterpillar and may not be used without permission.

AEXQ2470 (11-2018)
Build Number: 20A
(North America, Europe,
ANZ, Turkey, Korea)

